

C A T A L O G U E 2 0 2 1



HOTEL

R E L I A B L E

more than 50 years of experience
in the HO.RE.CA. sector



RESTAURANT

G U A R A N T E E D

Made in Italy quality: we manufacture
our products with the best materials



CATERING

C O M P L E T E

we grant you a comprehensive service
both before and after sales



HOSPITAL

T I M E L Y

our products are delivered quickly
and timely to meet all your needs

TANNER

www.rtanner.at

METALCARRELLI

  S I N C E 1 9 6 4  

ALL around YOUR BUSINESS

METALCARRELLI

 S I N C E 1 9 6 4 

ALL around YOUR BUSINESS

YOUR
INTERNATIONAL
PARTNER



- 1) EFFECTIVENESS OF THE GENERAL SALES TERMS AND CONDITIONS:** the general sales terms and conditions are deemed accepted on sending the order and finalised on acceptance of the order by Metalcarrelli s.r.l.
- 2) EXCEPTIONS/MODIFICATIONS:** the order implies full acceptance of our current sales terms and conditions to which NO exception or modification whatsoever is permitted, unless expressly agreed in writing.
- 3) INDIRECT ORDERS:** orders received by Metalcarrelli s.r.l. through intermediaries and/or sales agents are subordinate to the clause "subject to approval by the selling company" and the latter is therefore, free to refuse the order at its own uncontested discretion.
- 4) PRICES:** the listed prices applicable at the time the order is placed are ex-works and net of VAT. Metalcarrelli s.r.l. reserves the right to change prices without notification should there be significant changes in the cost of raw materials, labour or any other costs whatsoever (for example, fiscal costs). However, the final price applied to the customer will be the one indicated on the order confirmation.
- 5) PACKAGING:** in the event of shipping to the destination indicated by the customer, the material will be packed in boxes or pallets suited to the type of product. Any additional packaging will be charged to the customer and the additional price indicated on the order confirmation or in writing prior to shipment.
- 6) TRANSPORT:** goods travel at the sole risk of the customer, even if sold free port. Therefore, it is the recipient's responsibility to check the state of the material at the time of delivery.
- 7) COMPLAINTS:** in the event of any loss and/or damage to shipments the customer must send any complaints to Metalcarrelli s.r.l. within 24 hours of delivery in writing by registered letter with return receipt, to be forwarded in advance by fax or certified email.
 The guarantee is only valid if any damage is communicated within the timescale and using the methods described above, as well as following the below procedure: the customer/recipient should indicate the words "box not intact, goods accepted unchecked" on the transport document, accompanying invoice and/or delivery note, giving a brief description of the damage. Damaged goods should be kept in their original packaging and made available to Metalcarrelli s.r.l. for the appropriate checks. Metalcarrelli s.r.l. will not accept any responsibility whatsoever in the event of failure to comply with the above procedure.
- 8) DELIVERY TERMS:** the delivery terms indicated on the order confirmation are merely indicative. Any delays do not constitute a reason for waiving the purchase or modifying the agreements specified on the order and in no case whatsoever do they constitute a reason for compensation and/or claim for damages against Metalcarrelli s.r.l.
- 9) GUARANTEE:** the producer guarantees the goods for 12 months from the date of purchase. The guarantee is valid for faults due to the materials or processing, whilst electrical parts (resistors, thermostats, compressors, lamps, switches, etc.) and all materials subject to wear and tear (wheels, brushes, etc.) are excluded.
9a) Procedure for activating the guarantee: any products considered faulty must be carefully packed in their original packaging and returned to Metalcarrelli s.r.l. free port. Any intervention under guarantee will be carried out exclusively at our offices in Bellaria I.M. (RN), Italy and repaired or replaced material will be returned to the customer at no further cost. Any complaints and/or objections must be communicated no more than 8 (eight) days of the fault and/or defect being detected and in any case, within 12 months of delivery.
- 10) CERTIFICATION:** Metalcarrelli s.r.l. declares that the products illustrated in the catalogue comply with all European legislation applicable at the time of the order.
- 11) RETURNS:** Metalcarrelli s.r.l. will not accept either total or partial returns of goods sent to the customer, unless this is agreed in advance in writing by the parties. Acceptance of returns is at the uncontested discretion of Metalcarrelli s.r.l. In the event of a return being accepted, goods should be returned intact and unused, in their original packaging, at the sole expense and responsibility of the customer. In no case whatsoever will stainless steel items be accepted for returns if the protection has been removed. Likewise, special made-to-measure items cannot be returned.
- 12) PAYMENTS:** payments will not be valid unless made directly to Metalcarrelli s.r.l., either by bank transfer or cheque. In the event of payment being made to a person appointed by Metalcarrelli s.r.l., the said payment will only be deemed paid in full if the receipt is accompanied by a copy of the standard written authorisation by the company to its appointee. Any delays in payments as well as any other contractual breaches will lead to suspension of future supplies.
12a) interest on arrears: it is the faculty of the producer to apply commercial interest on arrears. In the event of any controversy, the purchaser does not have the right to delay or refuse to pay for supplies.
- 13) TITLE RETENTION:** sales with deferred payment are considered fulfilled with retention of title – TITLE RETENTION – in favour of the producer until the full balance has been paid. In the event, the customer cannot transfer goods until the balance payment has been made and failure to meet even a single deadline will imply the immediate return of goods if requested by Metalcarrelli s.r.l.
- 14) COMPETENT COURT:** in the event of any controversy regarding the fulfilment and/or interpretation of the order, acceptance of the same and/or the present clauses the parties agree that the only competent court will be the Court of Rimini.
- 15) INDICATIONS GIVEN IN THE CATALOGUE:** the producer reserves the right to modify, at any time and without notification, the dimensions and execution of the products listed in the present catalogue. The illustrations, photographs and descriptions in the catalogue applicable at the time of acceptance of the order should be considered general indications, however they do not constitute a restriction and may not correspond to the effective shape and structure of the products.
- 16) DRAWINGS AND ILLUSTRATIONS:** the various drawings and illustrations indicated by the producer along with the supply offer or contract, as well as those in the catalogue, are reserved for Metalcarrelli s.r.l. and are the sole property of the same.
- 17) BRANDS AND PATENTS:** it is expressly forbidden to use brands and/or patents registered by Metalcarrelli s.r.l.

The present catalogue cancels and replaces all previous ones. The images and product specifications contained herein are covered by copyright. Any use or reproduction of the same are subject to authorisation by Metalcarrelli S.r.l., which owns the brand and holds material and intellectual property rights. Prices may be subject to change in the event of printing errors.

SYMBOLS

	Heated wells or compartments		Suitable for Gastronorms
	Refrigerated wells or compartments		Suitable for trays
	Refrigerated and heated wells or compartments		H1 Hygiene system
	Neutral wells or compartments		Min/Max glass diameter
	Heating temperature: operating temperature range		Min/Max plate diameter
	Refrigeration temperature: operating temperature range		Gas powered
	Electrically powered		Ventilation system for heated and refrigerated elements
	Loading capacity: max loading capacity (total kg)		Sturdy: highly resistant to stress

KEY

	Walnut		Finish/Colour: finishes or colours available		Neutral
			Resilient castors/wheels for uneven floors and outdoor use		Hot
			Numbered photo or drawing		Cold
OPTIONAL			To be selected exclusively when placing the order		"C" shaped runners
ACCESSORY			Can be purchased later as well		"L" shaped runners
			Product shown on Metalcarrelli Youtube channel		Pressed runners

SUMMARY



1

Wooden service trolleys and waiter's stations

Metal service trolleys

p. 10



2

Display cases

Display trolleys

Buffets and drop-in units

p. 48



3

Breakfast trolleys

Bain-marie, refrigerated and neutral GN units for meal distribution

Conveyor belt

Refrigerated trolleys

Dispensers for plates and trays

p. 78



4

Countertop hotplates

Infrared lamps

Heated trolleys

Containers, lids and dividers

p. 96



5

Knife sterilizers

Tableware handling trolleys

Tray/pan trolleys

p. 136



6

Reception trolleys

Room service tables

Housekeeping trolleys

p. 188



7

Platform trucks

Roll containers

Changing room lockers

Hand washers

Storage shelving systems

p. 216



8

Waste bins, fast-food rubbish bins

Waste paper bins

















pag. 238





Wooden service trolleys and waiter's stations

Metal service trolleys

	GUÉRIDON _____	10
	WOODEN SERVICE TROLLEYS _____	14
	WOODEN SERVICE TROLLEYS WITH DOME _____	15
	EQUIPABLE WOODEN SERVICE TROLLEYS _____	16
	MODERN-STYLE WOODEN SERVICE TROLLEYS _____	18
	WOODEN SERVICE TROLLEY _____	21
	LIQUEUR TROLLEYS _____	22
	BAIN-MARIE TROLLEYS _____	23
	FLAMBÉ TROLLEYS _____	24
	WAITER'S STATIONS _____	26
	STAINLESS STEEL SERVICE TROLLEYS - MELAMINE-FACED SHELVES _____	32
	STAINLESS STEEL SERVICE TROLLEYS - WOOD EFFECT STEEL SHEET SHELVES _____	33
	STAINLESS STEEL CLEARING TROLLEYS _____	34
	STAINLESS STEEL SERVICE TROLLEYS - REMOVABLE SHELVES _____	36
	STAINLESS STEEL SERVICE TROLLEYS _____	38
	STAINLESS STEEL SERVICE TROLLEYS WITH PRESSED SHELVES _____	40
	STAINLESS STEEL HEAVY-DUTY TROLLEYS _____	43

GUÉRIDON

- Stainless steel square tube frame
- Melamine-faced shelves
- Top shelf fitted with all round rubber bumper
- Swivel castors, ø 9.5 cm



Article	€	Finish	Shelves	Max dim. cm
1095I	196,00	Oak	2	71x46x80 h
1095IW	196,00	Wengé		

Optional	€	📷	Description	Suitable for
F	10,00	1	Set with 2 braked castors	All articles
E	166,00	2	Set with 4 resilient castors, 2 with brake	

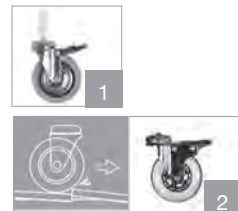

- Black, brass-plated or chrome-plated steel round tube frame
- Melamine-faced shelves
- Top shelf fitted with all round rubber bumper
- Swivel castors, ø 9.5 cm



Art. 1080



Art. 1088



Art. 1095CW

Article	€	Finish	Shelves	Leg finish	Max. dim. cm
1080	250,00	Black	2	Black	71x46x78 h
1088	305,00	Oak			
1088W	305,00	Wengé		Brass-plated	
1088N	315,00	Black		Chrome-plated	
1095C	267,00	Oak			
1095CW	267,00	Wengé			
1095CN	277,00	Black			

Optional	€	📷	Description	Suitable for
F	10,00	1	Set with 2 braked castors	All articles
E	166,00	2	Set with 4 resilient castors, 2 with brake	

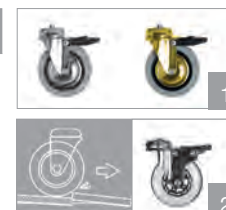

GUÉRIDON

- Solid wood frame
- Melamine-faced shelves
- Top shelf fitted with all round rubber bumper
- Swivel castors, ø 9.5 cm



Art. 1095S



Art. 1095SW

Article	€	Finish	Finish	Max dim. cm
1095S	229,00	Oak	2	71x46x78 h
1095SW	229,00	Wengé		

Optional	€	📷	Description	Suitable for
F	10,00	1	Set with 2 braked castors	All articles
E	166,00	2	Set with 4 resilient castors, 2 with brake	



- Solid wood frame
- Veneered MDF shelves
- Bottom shelf with raised edge
- Swivel castors, ø 12.5 cm

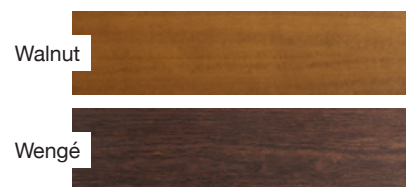

Art. 6000W

Article	€	Finish	Shelves	Max dim. cm
6000	489,00	Walnut	2	77x47x82 h
6000W	489,00	Wengé		

Optional	€	📷	Description	Suitable for
F	26,00	1	Set with 2 braked castors	All articles
E	99,00	2	Set with 4 resilient castors, 2 with brake	

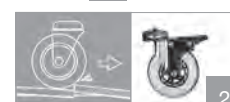

WOODEN SERVICE TROLLEYS

- Solid wood frame
- Melamine-faced shelves for Oak and Wengé models
- Melamine-faced black lacquered shelves
- Chrome plated pushing handle
- Rails on lower shelves
- Swivel castors, ø 12.5 cm



Art. 6061LN-F



Art. 6063W-F



Art. 6061-F

Article	€	Finish	Shelves	Shelf dim. cm	Max dim. cm
6061	492,00	Oak	2	94.5x55	110x56x81 h
6061W	492,00	Wengé			
6061LN	596,00	Lacquered Black			
6063	636,00	Oak	3	94.5x55	110x56x87 h
6063W	636,00	Wengé			
6063LN	772,00	Lacquered Black			

WOODEN SERVICE TROLLEYS WITH DOME

- Solid wood frame
- Melamine-faced shelves for Oak and Wengé models
- Melamine-faced black lacquered shelves
- Chrome plated pushing handle
- Plexiglass semi-cylindrical dome opening on both sides
- Rails on lower shelves
- Swivel castors, ø 12.5 cm



Art. 6061C-F



Art. 6063CW-F

Article	€	Finish	Shelves	Shelf dim. cm	Max dim. cm
6061C	762,00	Oak	2	94.5x55	110x56x107 h
6061CW	762,00	Wengé			
6061CN	866,00	Lacquered Black			
6063C	905,00	Oak	3	94.5x55	110x56x113 h
6063CW	905,00	Wengé			
6063CN	1.042,00	Lacquered Black			

Optional	€	📷	Description	Suitable for
F	26,00	1	Set with 2 braked castors	All articles
E	99,00	2	Set with 4 resilient castors, 2 with brake	



Accessories	€	📷	Description	Suitable for
A0096	69,00	3	Sliding PVC cutlery drawer	All articles
A0036	63,00	4	Sliding plate support, oak wood stained	6060C - 6062C
A0036W	63,00	5	Sliding plate support, wengé stained	6060CW - 6062CW
A0036LN	63,00	x	Sliding plate support, lacquered black	6061CLN - 6063CLN
R0822	65,00	6	12-bottle rack, chrome-plated steel wire	All articles
R0824	85,00		16-bottle rack, chrome-plated steel wire	

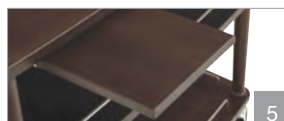

EQUIPABLE WOODEN SERVICE TROLLEYS

- Solid wood frame
- Plywood shelves with edges and handles in solid wood
- Sliding plate support
- Swivel castors, ø 12.5 cm

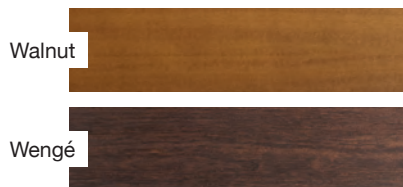

Art. 6100



Plate support, standard



Art. 6100W

Article	€	Finish	Shelves	Max dim. cm
6100	763,00	Walnut	2	107x55x82 h
6100W	763,00	Wengé		
6102	803,00	Walnut	3	
6102W	803,00	Wengé		
Optional	€	Description	Suitable for	
F	26,00	1 Set with 2 braked castors	All articles	1
E	99,00	2 Set with 4 resilient castors, 2 with brake		2



Art. 6100A
Display set for sweets and cheese including a solid wood board with semi-cylindrical dome



Art. 6100B
Set for appetizers, MDF well, semi-cylindrical dome, with 6.5 cm-deep 5x1/6 + 5x1/3 GN containers



Art. 6100C
Bottle holder with rails



Art. 6100E
Top 13-bottle wooden rack
Art. 6100F
Lower 9-bottle wooden rack



Art. 6100G
Set for cold appetizers, sweets and cheese, MDF well with inner part coated in stainless steel with semi-cylindrical dome, grid and housing for eutectic plates for refrigeration (Art. 6100H)



Art. 6100H
Set of 16 eutectic plates suitable for Art. 6100G



Art. R0822
Lower 12-bottle chrome-plated steel wire rack
Art. R0824
Top 16-bottle chrome-plated steel wire rack



Article	€	📷	Finish	Description	Max dim. cm
6100A	404,00	1	Walnut	Display set for sweets and cheese with dome	93x53x28 h
6100AW	404,00	-	Wengé		
6100B	577,00	2	Walnut	Set for appetizers - dome and containers	93x53x35 h
6100BW	577,00	-	Wengé		
6100C	240,00	3	Walnut	Top bottle holder with rails	93x53x28 h
6100CW	240,00	-	Wengé		
6100E	287,00	4	Walnut	Top 13-bottle wooden rack	88x47x20 h
6100EW	287,00	-	Wengé		
6100F	249,00	4	Walnut	Lower 9-bottle wooden rack	66x47x20 h
6100FW	249,00	-	Wengé		
6100G	700,00	5	Walnut	Set for cold appetizers	93x53x35 h
6100GW	700,00	-	Wengé		
6100H	54,00	6	-	Set with 16 eutectic plates	-
R0822	65,00	7	-	Lower 12-bottle steel wire rack	70x40x22 h
R0824	85,00			Top 16-bottle steel wire rack	90x40x22 h

MODERN-STYLE WOODEN SERVICE TROLLEYS - 70x45 cm SHELVES

- Square section solid wood legs
- MDF shelves
- Matt lacquer finishes
- Pushing handle built in the top shelf
- Sliding plate support (depending on the model)
- Swivel castors, ø 9.5 cm, 2 with brake

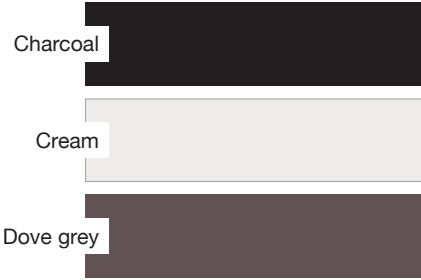

Art. 6830A



Art. 6832P

Article	€	Lacquer finish	Sliding plate support	Max dim. cm
6830A	453,00	Charcoal	-	70x45x84 h
6830P	453,00	Cream		
6830T	453,00	Dove grey		
6832A	541,00	Charcoal	Yes	
6832P	541,00	Cream		
6832T	541,00	Dove grey		
Optional	€	📷 Description	Suitable for	
E	166,00	1 Set with 4 resilient castors, 2 with brake	All articles	1

MODERN-STYLE WOODEN SERVICE TROLLEYS - 100x45 cm SHELVES

- Square section solid wood legs
- MDF shelves
- Matt lacquer finishes
- Pushing handle built in the top shelf
- Sliding plate support (depending on the model)
- Swivel castors, ø 9.5 cm, 2 with brake

Charcoal 

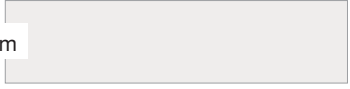
Cream 

Dove grey 

30 kg







Art. 6842T



Softclose closing for items with plate support



Art. 6840A

Article	€	Lacquer finish	Sliding plate support	Max dim. cm
6840A	481,00	Charcoal	-	100x45x84 h
6840P	481,00	Cream		
6840T	481,00	Dove grey		
6842A	568,00	Charcoal	Yes	
6842P	568,00	Cream		
6842T	568,00	Dove grey		
Optional	€	 Description	Suitable for	
E	166,00	1 Set with 4 resilient castors, 2 with brake	All articles	

MODERN-STYLE WOODEN SERVICE TROLLEYS - 100x56 cm SHELVES



- Square section solid wood legs
- MDF shelves
- Matt lacquer finishes
- Pushing handle built in the top shelf
- Sliding plate support (depending on the model)
- Top shelf with plexiglass semi-cylindrical dome opening on both sides (depending on the model)
- Swivel castors, ø 9.5 cm, 2 with brake



Art. 6854A

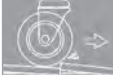

Art. 6850A

Article	€	Lacquer finish	Sliding plate support	Dome	Max dim. cm
6850A	506,00	Charcoal	-	-	100x56x84 h
6850P	506,00	Cream			
6850T	506,00	Dove grey			
6852A	591,00	Charcoal	Yes	-	100x56x84 h
6852P	591,00	Cream			
6852T	591,00	Dove grey			
6854A	914,00	Charcoal	Yes	Yes	100x56x110 h
6854P	914,00	Cream			
6854T	914,00	Dove grey			
Optional	€	 Description	Suitable for		 
E	166,00	1 Set with 4 resilient castors, 2 with brake	All articles		1

WOODEN SERVICE TROLLEY

- Mahogany stained wooden service trolley
- Veneered birch structure and shelves
- Solid mahogany wooden legs and frame
- Upper chrome-plated steel rail
- Double pushing handle
- Sliding cutlery drawer with compartments
- Wooden glass holder rack
- Swivel castors Ø 12.5 cm, 2 with brake

Mahogany



Wooden rack detail



Cutlery drawer detail



Art. 6103

Article	€	Finish	Shelves	Max dim. cm
6103	2.990,00	Mahogany	2	120x55x91 h

Optional	€	Description
E	99,00	1 Set with 4 resilient castors, 2 with brake



LIQUEUR TROLLEYS

- Solid wood frame
- Round plywood shelves
- Folding glass support
- Swivel castors, ø 8 cm

Walnut



Wengé



Art. 6310W

Article	€	Finish	Shelves	Max dim. cm
6310	721,00	Walnut	3	ø 59x80 h
6310W	721,00	Wengé		



BAIN-MARIE TROLLEYS

- Solid wood frame with plywood side panels and bottom shelf
- Pushing handle
- Stainless steel well suitable for up to 20 cm-deep GN containers (not included)
- Bain-Marie immersion heating element with protection grille
- Mains supply: 230V, 50/60 Hz, single-phase
- Bain-Marie condensation drain at the base of well with drain tap
- Digital thermometer/thermostat
- Sliding steel and polyethylene chopping board
- Knife rack
- Swivel castors, ø 12.5 cm

Optional Gastronorms: see pp. 132-133

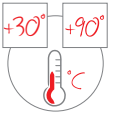
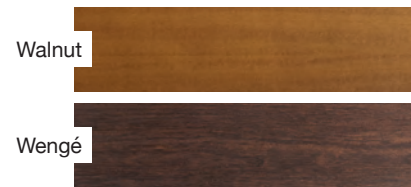

Art. 6600S + pans

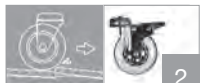

Art. 6602S + pans

Article	€	Finish	GN	Power	Max dim. cm	
6600S	1.386,00	Walnut	3x1/2	1950W	105x40x81 h	
6600SW	1.386,00	Wengé				
6602S	1.616,00	Walnut	3x1/1		121x61x81 h	
6602SW	1.616,00	Wengé				
Optional	€	📷	Description	Suitable for		
F	26,00	1	Set with 2 braked castors	All articles	 1	
E	99,00	2	Set with 4 resilient castors, 2 with brake		 2	
Accessories	€	📷	Finish	Description	Suitable for	
A0010	99,00	3	Walnut	Folding plate support	6600S	 3
A0010W	99,00	4	Wengé		6600SW	
A0011	99,00	3	Walnut		6602S	 5
A0011W	99,00	4	Wengé		6602SW	
A0015	67,00	5	-	Stainless steel lid holder	All articles	

FLAMBÉ TROLLEYS

- Melamine-faced frame and panels
- Stainless steel hob with flame failure safety device compliant with EC standards
- Side condiment folding shelf
- Chrome-plated steel bottle holder
- Cutlery drawer
- LPG cylinder housing door
- Swivel castors ø 12.5 cm, 2 with brake



Note: LPG cylinder and gas pressure regulator not included

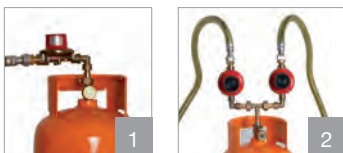

Article	€	Finish	Gas burners	Max dim.cm (open)	Max dim. cm (closed)
1160S	1.013,00	Oak	Single	123x50x87 h	95x50x87 h
1160SW	1.013,00	Wengé			
1160D	1.265,00	Oak	Double		
1160DW	1.265,00	Wengé			
1160	1.256,00	Oak	Twin		
1160W	1.256,00	Wengé			

Accessories	€	📷	Description	Suitable for
A80	56,00	1	Gas pressure regulator (LPG 30 mbar), single, c/w fittings	1160S - 1160SW -1160 -1160W
A82	133,00	2	Gas pressure regulator (LPG 30 mbar), double, c/w fittings	1160D - 1160DW
A81	56,00	1	Gas pressure regulator (LPG 50 mbar), single, c/w fittings	1160S - 1160SW -1160 -1160W
A83	133,00	2	Gas pressure regulator (LPG 50 mbar), double, c/w fittings	1160D - 1160DW

FLAMBÉ TROLLEYS

- Solid wood frame with plywood panels
- Stainless steel hob with flame failure safety device conforms to EC standards
- Top with metal spacers
- Side condiment folding shelf
- Chrome-plated steel bottle holder
- Cutlery drawers
- LPG cylinder housing door
- Swivel castors, ø 12.5 cm, 2 with brake

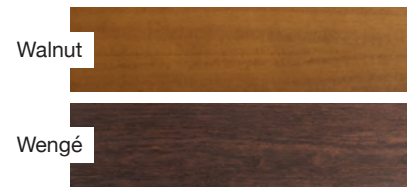

Note: LPG cylinder and gas pressure regulator not included



Art. 6400



Art. 6402



Art. 6404

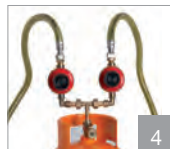

Article	€	Finish	Gas burners	Max dim.cm (open)	Max dim. cm (closed)
6404	1.477,00	Walnut	Single	133x55x81 h	118x55x81 h
6404W	1.477,00	Wengé			
6402	1.734,00	Walnut	Double		
6402W	1.734,00	Wengé			
6400	1.694,00	Walnut	Twin		
6400W	1.694,00	Wengé			

Optional	€	Description	Suitable for
E	99,00	2 Set with 4 resilient castors, 2 with brake	All articles

Accessories	€	Description	Suitable for
A80	56,00	3 Gas pressure regulator (LPG 30 mbar), single, c/w fittings	6400 - 6400W - 6404 - 6404W
A82	133,00	4 Gas pressure regulator (LPG 30 mbar), double, c/w fittings	6402 - 6402W
A81	56,00	3 Gas pressure regulator (LPG 50 mbar), single, c/w fittings	6400 - 6400W - 6404 - 6404W
A83	133,00	4 Gas pressure regulator (LPG 50 mbar), double, c/w fittings	6402 - 6402W



HIGH DOUBLE WAITER'S STATIONS

- Melamine-faced frame and panels
- 2 Upper shelves
- Cutlery drawers on runners, with dividers
- Each compartment has a inner adjustable shelf
- Castors, ø 5 cm



Matt lacquering.
RAL Please indicate the RAL code of the chosen colour.



Art. 1600



Cutlery drawer

Article	€	Finish	Description	Internal adjustable shelves	Max dim. cm
1600	808,00	Oak	2 Doors	2	94x48x145 h
1600W	825,00	Wengé			
1600RAL	1.364,00	RAL			
1605	1.213,00	Oak	2 Large flap-opening compartments	-	
1605W	1.227,00	Wengé			
1605RAL	1.765,00	RAL			
1606	1.010,00	Oak	1 Door + 1 flap-opening compartment	1	
1606W	1.027,00	Wengé			
1606RAL	1.564,00	RAL			
1607	774,00	Oak	1 Door + 1 open unit	2	
1607W	789,00	Wengé			
1607RAL	1.328,00	RAL			

HIGH DOUBLE WAITER'S STATIONS

- Melamine-faced frame and panels
- 2 Upper shelves
- Open cutlery drawers on runners, with dividers
- Each compartment has a inner adjustable shelf
- Castors, ø 5 cm



Matt lacquering.
RAL Please indicate the RAL code of the chosen colour.



Art. 1606FW



Open cutlery drawer

Article	€	Finish	Description	Internal adjustable shelves	Max dim. cm
1600F	808,00	Oak	2 Doors	2	94x48x145 h
1600FW	825,00	Wengé			
1600FRAL	1.364,00	RAL			
1605F	1.213,00	Oak	2 Large flap-opening compartments	-	
1605FW	1.227,00	Wengé			
1605FRAL	1.765,00	RAL			
1606F	1.010,00	Oak	1 Door + 1 flap-opening compartment	1	
1606FW	1.027,00	Wengé			
1606FRAL	1.564,00	RAL			
1607F	774,00	Oak	1 Door + 1 open unit	2	
1607FW	789,00	Wengé			
1607FRAL	1.328,00	RAL			

HIGH SINGLE WAITER'S STATIONS

- Melamine-faced frame and panels
- 2 Upper shelves
- Cutlery drawer on runners, with dividers
- Compartment with inner adjustable shelf
- Castors, ø 5 cm



Matt lacquering.
RAL Please indicate the RAL code of the chosen colour.



Art. 1610



Cutlery drawer

Article	€	Finish	Description	Internal adjustable shelf	Max dim. cm
1610	602,00	Oak	1 Door	1	48x48x145 h
1610W	618,00	Wengé			
1610RAL	1.103,00	RAL			
1615	803,00	Oak	1 flap-opening compartment	-	
1615W	819,00	Wengé			
1615RAL	1.303,00	RAL			
1616	567,00	Oak	1 Open unit	1	
1616W	584,00	Wengé			
1616RAL	1.066,00	RAL			

HIGH SINGLE WAITER'S STATIONS

- Melamine-faced frame and panels
- 2 Upper shelves
- Open cutlery drawers on runners, with dividers
- Compartment with inner adjustable shelf
- Castors, ø 5 cm

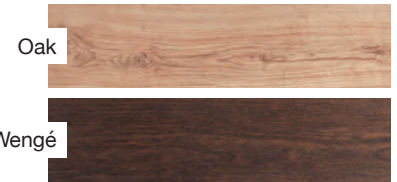

Matt lacquering.
RAL Please indicate the RAL code of the chosen colour.



Art. 1616FW



Open cutlery drawer

Article	€	Finish	Description	Internal adjustable shelf	Max dim. cm
1610F	602,00	Oak	1 Door	1	48x48x145 h
1610FW	618,00	Wengé			
1610FRAL	1.103,00	RAL			
1615F	803,00	Oak	1 flap-opening compartment	-	
1615FW	819,00	Wengé			
1615FRAL	1.303,00	RAL			
1616F	567,00	Oak	1 Open unit	1	
1616FW	584,00	Wengé			
1616FRAL	1.066,00	RAL			

LOW DOUBLE WAITER'S STATIONS

- Melamine-faced frame and panels
- Cutlery drawers on runners, with dividers
- Each compartment has a inner adjustable shelf
- Castors, ø 5 cm



Matt lacquering.
RAL Please indicate the RAL code of the chosen colour.



Art. 1620



Cutlery drawer

Article	€	Finish	Description	Internal adjustable shelves	Max dim. cm
1620	728,00	Oak	2 Doors	2	94x48x98 h
1620W	745,00	Wengé			
1620RAL	1.242,00	RAL			
1625	1.131,00	Oak	2 Large flap-opening compartments	-	
1625W	1.146,00	Wengé			
1625RAL	1.643,00	RAL			
1626	929,00	Oak	1 Door + 1 flap-opening compartment	1	
1626W	945,00	Wengé			
1626RAL	1.443,00	RAL			
1627	694,00	Oak	1 Door + 1 open unit	2	
1627W	709,00	Wengé			
1627RAL	1.206,00	RAL			

LOW DOUBLE WAITER'S STATIONS

- Melamine-faced frame and panels
- Open cutlery drawers on runners, with dividers
- Each compartment has a inner adjustable shelf
- Castors, ø 5 cm

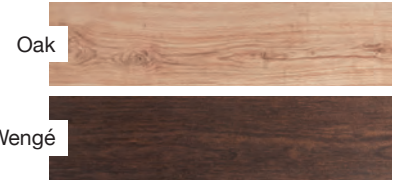

Matt lacquering.
RAL Please indicate the RAL code of the chosen colour.



Open cutlery drawer

Article	€	Finish	Description	Internal adjustable shelves	Max dim. cm
1620F	728,00	Oak	2 Doors	2	94x48x98 h
1620FW	745,00	Wengé			
1620FRAL	1.242,00	RAL			
1625F	1.131,00	Oak	2 Large flap-opening compartments	-	
1625FW	1.146,00	Wengé			
1625FRAL	1.643,00	RAL			
1626F	929,00	Oak	1 Door + 1 flap-opening compartment	1	
1626FW	945,00	Wengé			
1626FRAL	1.443,00	RAL			
1627F	694,00	Oak	1 Door + 1 open unit	2	
1627FW	709,00	Wengé			
1627FRAL	1.206,00	RAL			

STAINLESS STEEL SERVICE TROLLEYS - MELAMINE-FACED SHELVES

- Stainless steel 2x2 cm square tube frame, brushed finish
- Melamine-faced shelves with brushed stainless steel tubular edges
- Grey rubber ring buffers
- Swivel castors, ø 12.5 cm



Art. 4690.2T



Art. 4690.3

Article	€	Finish	Shelves	Shelf dim. cm	Max dim. cm		
4650.2	255,00	Oak	2	50x45	61x52x95 h		
4650.2T	275,00	Tobacco oak					
4650.3	325,00	Oak	3		61x52x103 h		
4650.3T	351,00	Tobacco oak					
4650.4	401,00	Oak	4			61x52x137 h	
4650.4T	432,00	Tobacco oak					
4670.2	266,00	Oak	2	70x45			81x52x95 h
4670.2T	287,00	Tobacco oak					
4670.3	341,00	Oak	3		81x52x103 h		
4670.3T	368,00	Tobacco oak					
4670.4	423,00	Oak	4			81x52x137 h	
4670.4T	456,00	Tobacco oak					
4690.2	286,00	Oak	2	90x45			101x52x95 h
4690.2T	309,00	Tobacco oak					
4690.3	372,00	Oak	3		101x52x103 h		
4690.3T	402,00	Tobacco oak					
4690.4	464,00	Oak	4			101x52x137 h	
4690.4T	500,00	Tobacco oak					

Optional	€	📷	Description	Suitable for
F	22,00	1	Set with 2 braked castors	All articles
E	166,00	2	Set with 4 resilient castors, 2 with brake	
Accessories	€	📷	Description	Suitable for
AB02	33,00	3	PVC waste bin, 33x16x51 h cm	All articles
AB01	16,00	4	PVC waste bin, 35x19x18 h cm	



STAINLESS STEEL SERVICE TROLLEYS - WOOD EFFECT STEEL SHEET SHELVES

- Stainless steel round tube frame, ø 2.5 cm
- Plastic coated steel sheet shelves, wood effect finish
- No sharp edges
- Die-cast aluminium corner joints fixing shelves to the frame with rounded inner corners
- Plexiglass semi-cylindrical dome opening on both sides (depending on the model)
- Grey rubber ring buffers
- Swivel castors, ø 12.5 cm

Walnut

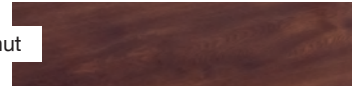

Art. 4100



Art. 4018

Article	€	Shelves	Dome	Shelf dim. cm	Max dim. cm
4006	303,00	2	-	71x45	87x52x96 h
4008	395,00	3			87x52x96 h
4010	496,00	4			87x52x130 h
4018	310,00	2	-	71x52	87x59x96 h
4020	405,00	3			87x59x96 h
4022	509,00	4			87x59x130 h
4000	318,00	2	-	93x45	108x52x96 h
4002	422,00	3			108x52x96 h
4004	529,00	4			108x52x130 h
4012	327,00	2	-	93x52	108x59x96 h
4014	431,00	3			108x59x96 h
4016	544,00	4			108x59x130 h
4100	676,00	2	Yes	93x52	108x59x112 h
4102	789,00	3			108x59x112 h

Optional	€		Description	Suitable for
F	22,00	1	Set with 2 braked castors	All articles
E	166,00	2	Set with 4 resilient castors, 2 with brake	
Accessories	€		Description	Suitable for
AB02	33,00	3	PVC waste bin, 33x16x51 h cm	All articles
AB01	16,00	4	PVC waste bin, 35x19x18 h cm	
A0097	94,00	5	3-compartment PVC cutlery drawer	



STAINLESS STEEL CLEARING TROLLEYS

- AISI 304 stainless steel 2.5x2.5 cm square tube frame, brushed finish
- Upper shelf for up to 3x20 cm-deep GN 1/1 pans (not included)
- Lower removable stainless steel shelves
- Grey rubber ring buffers
- Swivel castors, ø 12.5 cm



Optional Gastronorms: see pp. 132-133



Art. 1550F + pans

Article	€	Shelves	Shelf dim. cm	Max dim. cm
1550	334,00	1	100x50	112x62x94 h
1552	455,00	2		112x62x112 h

Optional	€	📷	Description	Suitable for
F	22,00	1	Set with 2 braked castors	All articles
E	166,00	2	Set with 4 resilient castors, 2 with brake	



1



2

STAINLESS STEEL CLEARING TROLLEYS

- AISI 304 stainless steel 2.5x2.5 cm square tube frame with stainless steel sheet side panels welded throughout the length, brushed finish
- Stainless steel sheet lower shelf with raised edge
- Grey rubber ring buffers
- Swivel castors, ø 12.5 cm



Optional Gastronorms: see pp. 132-133



Art. 1515V-F







Watertight well detail (1515V)



Detail for structure without bottom (1515S)



Art. 1515-F

Article	€	Description	Max H pans cm	Shelf dim. cm	Max dim. cm
1515S	434,00	Holding structure without bottom for 3x1/1 GN pans (not included)	20	105x51	117x63x94 h
1515	687,00	Structure without bottom + pans 1x2/1 GN + 2x1/2 GN (included)			
1515V	686,00	Watertight well + tap			
Optional	€	Description	Suitable for		
F	22,00	1 Set with 2 braked castors	All articles	 1	
E	166,00	2 Set with 4 resilient castors, 2 with brake		 2	
Accessories	€	Description	Suitable for		
AB02	33,00	3 PVC waste bin, 33x16x51 h cm	All articles	 3	
AB01	16,00	4 PVC waste bin, 35x19x18 h cm		 4	

STAINLESS STEEL SERVICE TROLLEYS - REMOVABLE SHELVES

- AISI 304 stainless steel 2x2 cm square tube frame, brushed finish
- Stainless steel 1.5 or 6.5 cm-deep tray shelves (depending on the model) with 90° no-sharp edges
- Grey rubber ring buffers
- Swivel castors, ø 12.5 cm



Art. 1516



Removable shelf detail



Art. 1526

Article	€	Shelves	Shelf depth cm	Shelf dim. cm	Max dim. cm
1516	247,00	2	1,5	47x44	58x51x91 h
1517	309,00	3			58x51x110 h
1520	277,00	2		75x44	86x51x91 h
1521	352,00	3			86x51x110 h
1522	427,00	4			86x51x126 h
1523	291,00	2		87x44	98x51x91 h
1524	373,00	3			98x51x110 h
1525	454,00	4			98x51x126 h
1526	344,00	2	6,5	87x44	98x51x91 h
1527	454,00	3			98x51x110 h

Optional	€	Image	Description	Suitable for
F	22,00		Set with 2 braked castors	All articles
E	166,00		Set with 4 resilient castors, 2 with brake	
Accessories	€	Image	Description	Suitable for
AB02	33,00		PVC waste bin, 33x16x51 h cm	All articles
AB01	16,00		PVC waste bin, 35x19x18 h cm	

AISI 304 STAINLESS STEEL SERVICE TROLLEYS - REMOVABLE SHELVES

- AISI 304 stainless steel trolleys, brushed finish
- Round tube frame ø 2.5 cm
- Removable soundproof tray-shaped shelves, with no sharp edges
- Grey rubber ring buffers
- Swivel castors, ø 12.5 cm, 2 with brake



Removable shelf detail



Art. 14208EST

Article	€	Shelves	Shelf dim. cm	Capacity Kg	Max dim. cm
14208EST	366,00	2	70x50	120	98x62x94 h
14308EST	483,00	3			
14210EST	405,00	2	90x50		118x62x94 h
14310EST	546,00	3			

Optional	€	📷	Description	Suitable for	📷
E	166,00	1	Set with 4 resilient castors, 2 with brake	All articles	1
Accessories	€	📷	Description	Suitable for	📷
AB02	33,00	2	PVC waste bin, 33x16x51 h cm	All articles	2
AB01	16,00	3	PVC waste bin, 35x19x18 h cm		3

STAINLESS STEEL SERVICE TROLLEYS

- L-shaped stainless steel sheet frame, brushed finish
- Stainless steel 4 cm-deep tray shelves with 90° no-sharp edges, bolted to the frame
- Pushing handle
- Swivel castors, ø 9.5 cm



Art. 1545



Art. 1548

Article	€	Shelf dim. cm	Dim. piani cm	Max dim. cm
1545	328,00	2	80x45	89x48x85 h
1546	378,00	3		
1547	339,00	2	90x50	99x53x85 h
1548	395,00	3		

Optional	€	Description	Suitable for
F	10,00	1 Set with 2 braked castors	All articles
E	166,00	2 Set with 4 resilient castors, 2 with brake	
Accessories	€	Description	Suitable for
AB02	33,00	3 PVC waste bin, 33x16x51 h cm	All articles
AB01	16,00	4 PVC waste bin, 35x19x18 h cm	



STAINLESS STEEL SERVICE TROLLEYS

- AISI 304 stainless steel trolleys, brushed finish
- Plexiglass semi-cylindrical dome opening on both sides (depending on model)
- Stainless steel round tube frame, ø 2.5 cm
- Stainless steel 2 cm-deep tray shelves
- No sharp edges
- Die-cast aluminium corner joints fixing the shelves to the frame with rounded inner corners
- Grey rubber ring buffers
- Swivel castors, ø 12.5 cm



Art. 4052



Art. 4150

Article	€	Shelves	Dome	Shelf dim. cm	Max dim. cm
4056	317,00	2	-	71x45	87x52x96 h
4058	413,00	3			87x52x130 h
4060	520,00	4			
4068	328,00	2	-	71x52	87x59x96 h
4070	430,00	3			87x59x130 h
4072	542,00	4			
4050	339,00	2	-	93x45	108x52x96 h
4052	446,00	3			108x52x130 h
4054	563,00	4			
4062	352,00	2	-	93x52	108x59x96 h
4064	466,00	3			108x59x130 h
4066	592,00	4			
4150	666,00	2	Yes	93x52	108x59x112 h
4152	783,00	3			

Optional	€	Image	Description	Suitable for
F	22,00		Set with 2 braked castors	All articles
E	166,00		Set with 4 resilient castors, 2 with brake	
Accessories	€	Image	Description	Suitable for
A0097	94,00		PVC 3-compartment cutlery drawer	All articles
AB02	33,00		PVC waste bin, 33x16x51 h cm	
AB01	16,00		PVC waste bin, 35x19x18 h cm	

STAINLESS STEEL SERVICE TROLLEYS WITH PRESSED SHELVES

- AISI 201 stainless steel trolleys
- Round tube frame \varnothing 2.5 cm
- Tray shaped stainless steel pressed shelves bolted to the frame, sound-proof and with no sharp edges, brushed finish
- Grey rubber buffers
- Swivel castors \varnothing 10 cm, 2 with brake
- MADE IN PRC



Art. 2P100-50



Art. 3P100-50

Article	€	Shelves	Shelf dim. cm	Max dim. cm
2P80-50	181,00	2	80x50	89x59x94 h
3P80-50	234,00	3		
2P100-50	202,00	2	100x50	109x59x94 h
3P100-50	249,00	3		
2P100-60	221,00	2	100x60	109x69x94 h
3P100-60	275,00	3		

Accessories	€	📷	Description	Suitable for
AB01	16,00	1	PVC waste bin, 35x19x18 h cm	All articles
AB02	33,00	2	PVC waste bin, 33x16x51 h cm	



AISI 304 STAINLESS STEEL SERVICE TROLLEYS WITH BOLTED PRESSED SHELVES

- AISI 304 stainless steel trolleys, brushed finish
- Round tube frame ø 2.5 cm
- Tray shaped stainless steel pressed shelves bolted to the frame, sound-proof and with no sharp edges
- Grey rubber ring buffers
- Swivel castors, ø 12.5 cm



Waste hole detail



Art. 1400

Article	€	Shelves	Shelf dim. cm	Max dim. cm
1400C	276,00	2	80x50	89x59x95 h
1405C	353,00	3		89x59x95 h
1410C	443,00	4		89x59x126 h
1400C5	542,00	5		89x59x160 h
1400	306,00	2	100x50	109x59x95 h
1405	398,00	3		109x59x95 h
1410	501,00	4		109x59x126 h
14005	612,00	5		109x59x160 h
1402	326,00	2	100x60	109x69x95 h
1407	428,00	3		109x69x95 h
1412	539,00	4		109x69x126 h
14025	653,00	5		109x69x160 h
14032	381,00	2	120x60	129x69x95 h
14033	510,00	3		129x69x95 h
14034	650,00	4		129x69x126 h

Optional	€	Description	Suitable for
F	22,00	1 Set with 2 braked castors	All articles
E	166,00	2 Set with 4 resilient castors, 2 with brake	
FO	80,00	3 1 waste hole (recommended for items with 2/3 shelves)	

Accessories	€	Description	Suitable for
AB01	16,00	4 PVC waste bin, 35x19x18 h cm	All articles
AB02	33,00	5 PVC waste bin, 33x16x51 h cm	



AISI 304 STAINLESS STEEL SERVICE TROLLEYS WITH WELDED PRESSED SHELVES

- AISI 304 stainless steel trolleys, brushed finish
- Round tube frame ø 2.5 cm
- Tray shaped stainless steel pressed shelves welded to the frame, sound-proof and with no sharp edges
- Grey rubber ring buffers
- Swivel castors, ø 12.5 cm



Art. 1405S



Welded shelf detail



Waste hole detail

Article	€	Shelves	Shelf dim. cm	Max dim. cm
1400CS	310,00	2	80x50	89x59x95 h
1405CS	386,00	3		89x59x126 h
1410CS	540,00	4		89x59x126 h
1400S	339,00	2	100x50	109x59x95 h
1405S	430,00	3		109x59x126 h
1410S	599,00	4		109x59x126 h
1402S	363,00	2	100x60	109x69x95 h
1407S	462,00	3		109x69x126 h
1412S	644,00	4		109x69x126 h
14032S	397,00	2	120x60	129x69x95 h
14033S	517,00	3		129x69x126 h
14034S	660,00	4		129x69x126 h

Optional	€	Description	Suitable for
F	22,00	1 Set with 2 braked castors	All articles
E	166,00	2 Set with 4 resilient castors, 2 with brake	
FO	80,00	3 1 waste hole (recommended for items with 2/3 shelves)	

Accessories	€	Description	Suitable for
AB01	16,00	4 PVC waste bin, 35x19x18 h cm	All articles
AB02	33,00	5 PVC waste bin, 33x16x51 h cm	



STAINLESS STEEL HEAVY-DUTY TROLLEYS

- AISI 304 stainless steel trolleys, brushed finish
- Round tube closed frame ø 2.5 cm
- Tray shaped stainless steel pressed shelves welded to the frame, sound-proof and with no sharp edges
- Grey rubber ring buffers
- Swivel castors ø 12.5 cm, 2 with brake



Waste hole detail



Art. 1402P

Article	€	Shelves	Shelf dim. cm	Max dim. cm
1400CP	386,00	2	80x50	89x59x95 h
1405CP	460,00	3		
1400P	418,00	2	100x50	109x59x95 h
1405P	510,00	3		
1402P	446,00	2	100x60	109x69x95 h
1407P	546,00	3		
1403P2	530,00	2	120x60	129x69x95 h
1403P3	667,00	3		

Optional	€	📷	Description	Suitable for
E	90,00	1	Set with 4 resilient castors, 2 with brake	All articles
FO	80,00	2	1 waste hole	



Accessories	€	📷	Description	Suitable for
AB01	16,00	3	PVC waste bin, 35x19x18 h cm	All articles
AB02	33,00	4	PVC waste bin, 33x16x51 h cm	



STAINLESS STEEL HEAVY-DUTY TROLLEYS

- AISI 304 stainless steel trolleys, brushed finish
- Stainless steel 2.5x2.5 cm square tube frame
- Steel sheet pressed flat shelves (PL range) or deep tray shelves (PV range), welded to the frame
- Grey rubber ring buffers
- Swivel castors with plate support, ø 12.5 cm, 2 with brake



Art. 1560-2PV

Article	€	Shelves	Shelf dim. cm	Max dim. cm
1560-2PL	445,00	2 Flat	100x58	108x61x93 h
1560-3PL	530,00	3 Flat		
1560-2PV	454,00	2 Deep tray		
1560-3PV	544,00	3 Deep tray		

Accessories	€	📷	Description	Suitable for
AB02	33,00	2	PVC waste bin, 33x16x51 h cm	All articles
AB01	16,00	3	PVC waste bin, 35x19x18 h cm	



STAINLESS STEEL HEAVY-DUTY TROLLEYS

- AISI 304 stainless steel trolleys, brushed finish
- Stainless steel 2.5x2.5 cm square tube frame
- Steel sheet pressed flat shelves (PL range) or deep tray shelves (PV range) with reinforcing bar, welded to the frame
- Rubber corner bumpers
- Swivel castors with support plate and roller bearings, ø 16 cm, 2 with brake



Art. 1570-2PV

Article	€	Shelves	Shelf dim. cm	Max dim. cm
1570-2PL	672,00	2 Flat	100x58	108x61x96 h
1570-3PL	807,00	3 Flat		
1570-2PV	681,00	2 Deep tray		
1570-3PV	818,00	3 Deep tray		

Accessories	€	📷	Description	Suitable for
AB02	33,00	1	PVC waste bin, 33x16x51 h cm	All articles
AB01	16,00	2	PVC waste bin, 35x19x18 h cm	







Display cases
Display trolleys
Buffets and drop-in units

	HEATED DISPLAY CASES _____	48
	REFRIGERATED DISPLAY CASES _____	50
	REFRIGERATED TROLLEYS _____	52
	REFRIGERATED SELF-SERVICE BUFFET TROLLEYS _____	56
	HEATED SELF-SERVICE BUFFET TROLLEYS _____	60
	MIXED HOT/COLD SELF-SERVICE BUFFET TROLLEYS _____	66
	COMPLEMENTARY ELEMENTS FOR SELF-SERVICE BUFFETS _____	70
	DROP-IN UNITS _____	72

HEATED DISPLAY CASES

- Fully stainless steel sheet construction, insulated with injected high density expanded polyurethane
- 180° opening tempered glass doors on 2 sides with no sharp edges and removable PVC door seals for easy cleaning
- Snap-closing hinges
- Stainless steel tube side pushing handles with PVC brackets
- Ventilated heating, power 2000W
- Control panel with digital thermostat-thermometer and ON/OFF switch with warning light

- Mains supply: 230V, 50Hz (60 Hz upon request), single-phase
- 3-mt long coiled power cable
- Swivel castors ø 12.5 cm, 2 with brake

INTERNAL OPTIONS:

- Rack with 27 grills spaced 4 cm for 65x65 cm grills (standard model supplied with 15 grills spaced 8 cm)
- OR:
- Plate holder with different capacities

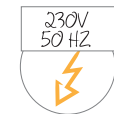
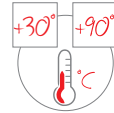

Art. 3360GS

Article	€	Supports	Power	Max dim. cm
3360GS	2.828,00	15 Grills	2000W	83x77x190 h

Optional	€	Description
A0054	32,00	65x65 cm Grill

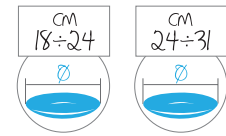

Art. 3360PS-88

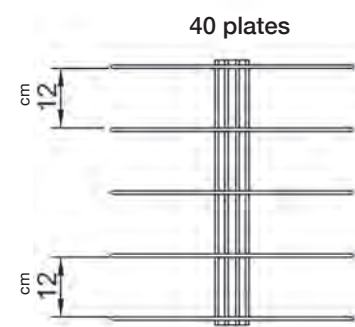
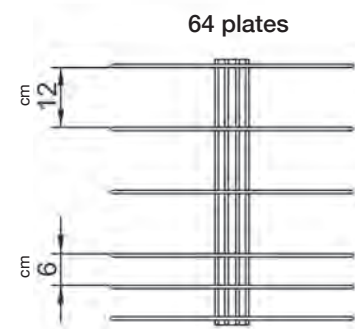
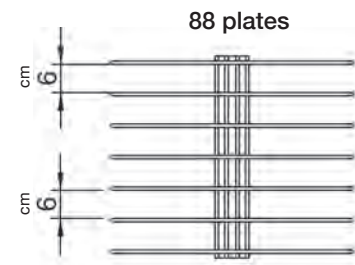

Article	€	Plate Ø cm	Supports	Plate N.	Power	Max dim. cm
3360PS-40	2.661,00	18÷24	Plate holder	40	2000W	83x77x190 h
3360PS-64	2.684,00			64		
3360PS-88	2.707,00			88		
3361PS-40	2.670,00	24÷31		40		
3361PS-64	2.699,00			64		
3361PS-88	2.729,00			88		

REFRIGERATED DISPLAY CASES

- Fully stainless steel sheet construction, insulated with injected high density expanded polyurethane
- Stainless steel watertight deep base with drain hole
- 180° opening tempered glass doors on 2 sides with no sharp edges and removable PVC door seals for easy cleaning
- Snap-closing hinges
- Stainless steel tube side pushing handles with PVC brackets
- Control panel with digital thermostat-thermometer and ON/OFF switch with warning light
- Mains supply: 230V, 50 Hz (60 Hz upon request), single-phase

- Static refrigeration +4°C +10°C
- 3-mt long coiled power cable
- Swivel castors ø 12.5 cm, 2 with brake

INTERNAL OPTIONS:

- Rack with 27 grills spaced 4 cm for 65x65 cm grills (standard model supplied with 15 grills spaced 8 cm)
- OR:
- Plate holder with different capacities

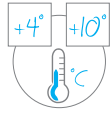

Art. 3370GS

Article	€	Supports	Power	Max dim. cm
3370GS	3.347,00	15 Grills	1200W	83x77x190 h

Optional	€	Description
A0055	32,00	65x65 cm Grill

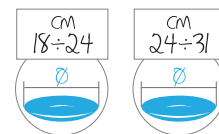

Art. 3370PS-88

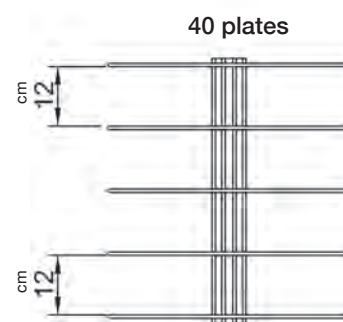
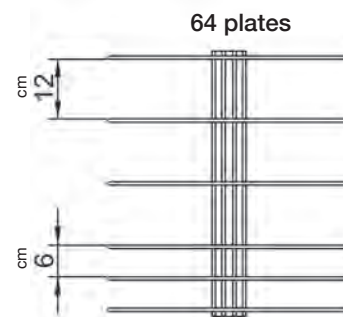
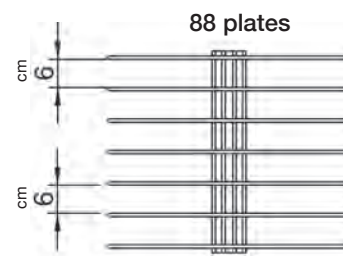

Article	€	Plate Ø cm	Supports	Plate N.	Power	Max dim. cm
3370PS-40	3.255,00	18÷24	Plate holder	40	1200W	83x77x190 h
3370PS-64	3.279,00			64		
3370PS-88	3.301,00			88		
3371PS-40	3.263,00	24÷31		40		
3371PS-64	3.293,00			64		
3371PS-88	3.323,00			88		

REFRIGERATED TROLLEYS FOR SWEETS AND CHEESE

- Solid wood frame with plywood panels and shelf
- Front opening plexiglass dome
- Glass shelf
- Static refrigeration +4°C +10°C
- Back panel and perforated false bottom
- Condensation drain at the base of the well (drain tap available on request)

- 3-Compartment cutlery drawer and sliding plate support
- Control panel with digital thermostat-thermometer and ON/OFF switch with warning light
- Mains supply: 230V, 50 Hz (60 Hz upon request), single-phase
- Swivel castors, ø 10 cm

Cherry wood

Wengé

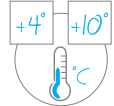

Art. 6670-18W

Cutlery drawer



Sliding plate support



Article	€	Finish	Power	Max. dim. cm
6670-18	2.978,00	Cherry wood	130W	108x61x112 h
6670-18W	2.978,00	Wengé		108x61x112 h

Optional	€	📷	Description	Suitable for
F	26,00	1	Set with 2 braked castors	All articles
E	99,00	2	Set with 4 resilient castors, 2 with brake	
A156	37,00	-	Drain tap	
A0039	28,00	3	Pushing handle	

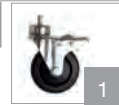

REFRIGERATED TROLLEYS

- Plexiglass semi-cylindrical dome opening on both sides
- Plywood panels and shelf
- AISI 304 stainless steel legs, brushed finish
- For BLACK finish: structure in water-repellent MDF with transparent coating
- AISI 304 stainless steel 19 cm-deep well for up to 15 cm-deep GN pans (not included)
- Condensation drain hole at the

base of the well (drain tap available on request) **Note: the drain tap is necessary for fish displaying**

- Control panel with digital thermostat-thermometer and ON/OFF switch with warning light
- Mains supply: 230V, 50 Hz (60 Hz upon request), single-phase
- Static refrigeration +4°C +10°C
- Swivel castors ø 12.5 cm, 2 with brake



Art. 6930.3W + A20(x3)

Complementary elements see pp. 70-71
Optional Gastronorms: see pp. 132-133

Note: when ordering one single front shelf, it is mounted on the opposite side to the operator one, unless otherwise specified.

Article	€	Finish	GN	Power	Max dim. cm	Optional	€	Front shelf
6930.2R	2.866,00	Oak	2x1/1	190W	80x68x120 h	A122R	137,00	1 drop-down shelf with tray slide
6930.2W	2.866,00	Wengé				A122W	137,00	
6930.2N	3.259,00	Black				A122N	159,00	
6930.2RAL	3.451,00	RAL				A122RAL	170,00	
6930.3R	3.105,00	Oak	3x1/1	350W	113x68x120 h	A123R	170,00	1 drop-down shelf with tray slide
6930.3W	3.105,00	Wengé				A123W	170,00	
6930.3N	3.531,00	Black				A123N	198,00	
6930.3RAL	3.731,00	RAL				A123RAL	227,00	
6930.4R	3.491,00	Oak	4x1/1	450W	161x68x120 h	A124R	208,00	1 drop-down shelf with tray slide
6930.4W	3.491,00	Wengé				A124W	208,00	
6930.4N	3.969,00	Black				A124N	242,00	
6930.4RAL	4.155,00	RAL				A124RAL	273,00	

Optional	€	Description	Suitable for
A156	37,00	Drain tap (necessary for fish displaying)	All articles
Accessories	€	Description	Suitable for
A10	31,00	1 1/1 GN Flat	All articles
A20	36,00	2 1/1 GN Perforated	
LED	258,00	Well lighting	

SELF-SERVICE BUFFET TROLLEYS OVERVIEW

GENERAL FEATURES

- Stainless overhead gantry
- Fixed plexiglass sneeze guard OR height-adjustable tempered glass sneeze guard
- Plywood panels, shelf (and doors in the cupboard version)
- AISI 304 stainless steel legs, brushed finish
- AISI 304 stainless steel 19 cm-deep well for up to 15 cm-deep GN pans (not included)
- Swivel castors \varnothing 12.5 cm, 2 with brake

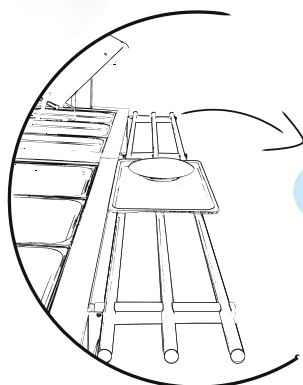

Drop-down front stainless steel rodded tray slide

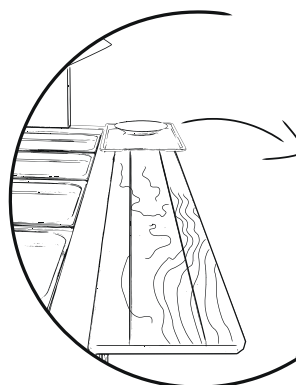

Drop-down front shelf with tray slide

SELF-SERVICE BUFFET TROLLEYS OVERVIEW



Cupboard version

Swivel castors
ø 12.5 cm
2 with brake

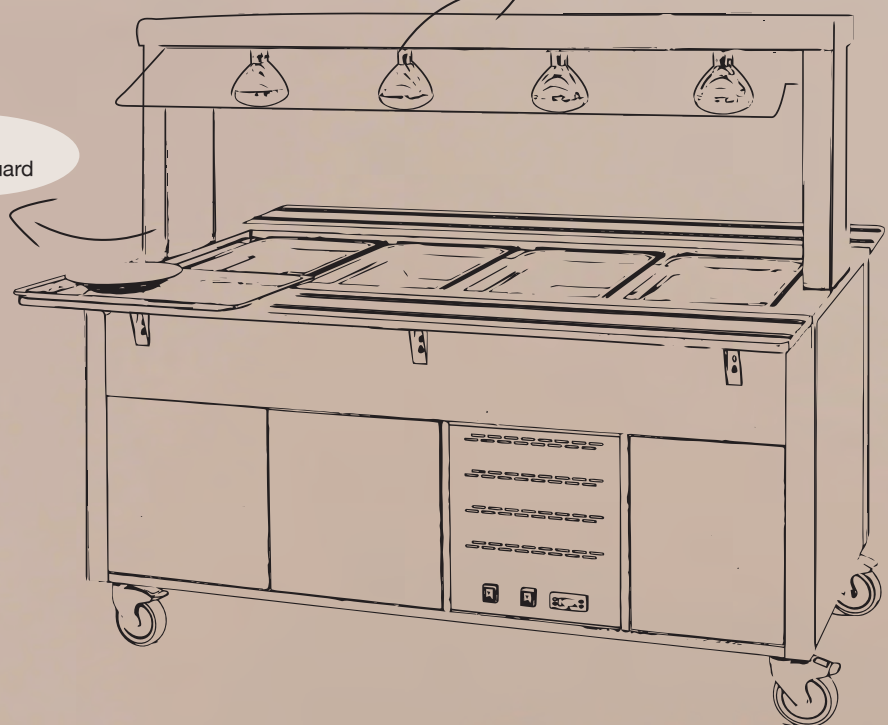

Infrared lamps

Fixed
sneeze guard

REFRIGERATED SELF-SERVICE BUFFET TROLLEYS - FIXED SNEEZE GUARD - LED LIGHTING

- Stainless steel overhead gantry with led lighting
- Fixed plexiglass sneeze guard
- Plywood panels, shelf (and doors in the cupboard version)
- AISI 304 stainless steel legs, brushed finish
- For BLACK finish: structure in water-repellent MDF with transparent coating
- AISI 304 stainless steel 19 cm-deep well for up to 15 cm-deep GN pans (not included)
- Condensate drain at the base of the well (drain tap available on request)
Note: the drain tap is necessary for fish displaying
- Control panel with digital thermostat-thermometer and ON/OFF switch with warning light
- Mains supply: 230V, 50 Hz (60 Hz upon request), single-phase
- Static refrigeration +4°C +10°C
- Swivel castors ø 12.5 cm, 2 with brake

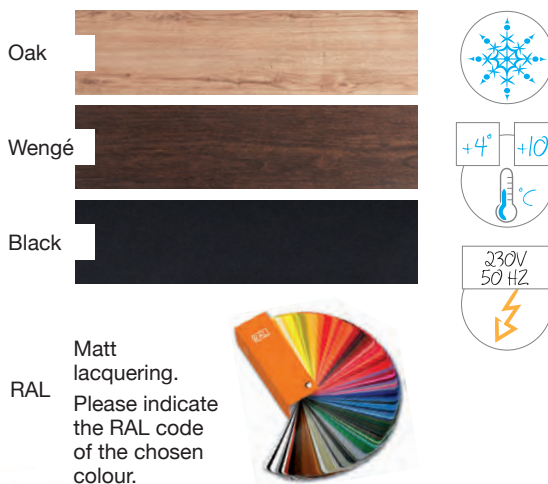

Complementary elements see pp. 70-71

Optional Gastronorms: see pp. 132-133

Art. 6900.4-W + A124W(x2) + A156 + A20(x4)

OPEN LOWER PART VERSION

Article	€	Finish	Typology	GN	Power	Max dim. cm	Optional	€	Lateral shelf	Optional	€	Front shelf
6900.2-R	2.688,00	Oak	OPEN LOWER PART	2x1/1	190W	80x68x144 h	A120R	137,00	1 fixed with tray slide	A122R	137,00	1 drop-down with tray slide
6900.2-W	2.688,00	Wengé					A120W	137,00		A122W	137,00	
6900.2-N	3.092,00	Black					A120N	159,00		A122N	159,00	
6900.2-RAL	3.280,00	RAL					A120RAL	174,00		A122RAL	170,00	
6900.3-R	2.981,00	Oak	OPEN LOWER PART	3x1/1	350W	113x68x144 h	A120R	137,00	1 fixed with tray slide	A123R	170,00	1 drop-down with tray slide
6900.3-W	2.981,00	Wengé					A120W	137,00		A123W	170,00	
6900.3-N	3.428,00	Black					A120N	159,00		A123N	198,00	
6900.3-RAL	3.637,00	RAL					A120RAL	174,00		A123RAL	227,00	
6900.4-R	3.436,00	Oak	OPEN LOWER PART	4x1/1	450W	161x68x144 h	A120R	137,00	1 fixed with tray slide	A124R	208,00	1 drop-down with tray slide
6900.4-W	3.436,00	Wengé					A120W	137,00		A124W	208,00	
6900.4-N	3.952,00	Black					A120N	159,00		A124N	242,00	
6900.4-RAL	4.192,00	RAL					A120RAL	174,00		A124RAL	273,00	
6900.5-R	3.798,00	Oak	OPEN LOWER PART	5x1/1	460W	193x68x144 h	A120R	137,00	1 fixed with tray slide	A125R	273,00	1 drop-down with tray slide
6900.5-W	3.798,00	Wengé					A120W	137,00		A125W	273,00	
6900.5-N	4.367,00	Black					A120N	159,00		A125N	318,00	
6900.5-RAL	4.634,00	RAL					A120RAL	174,00		A125RAL	384,00	
6900.6-R	4.158,00	Oak	OPEN LOWER PART	6x1/1	460W	226x68x144 h	A120R	137,00	1 fixed with tray slide	A126R	311,00	1 drop-down with tray slide
6900.6-W	4.158,00	Wengé					A120W	137,00		A126W	311,00	
6900.6-N	4.782,00	Black					A120N	159,00		A126N	362,00	
6900.6-RAL	5.073,00	RAL					A120RAL	174,00		A126RAL	469,00	

Note: when ordering one single front shelf, it is mounted on the opposite side to the operator one, unless otherwise specified.

REFRIGERATED SELF-SERVICE BUFFET TROLLEYS - FIXED SNEEZE GUARD - LED LIGHTING





Art. 6900CPB.4-N + A124N(x2) +A10(x3) + A20(x1)

CUPBOARD VERSION: with back panel, side panels and doors

Note: when ordering one single front shelf, it is mounted on the opposite side to the operator one, unless otherwise specified.

Article	€	Finish	Typology	GN	Power	Max dim. cm	Optional	€	Lateral shelf	Optional	€	Front shelf
6900CPB.2-R	3.360,00	Oak	CUPBOARD	2x1/1	190W	80x68x144 h	A120R	137,00	1 fixed with tray slide	A122R	137,00	1 drop-down with tray slide
6900CPB.2-W	3.360,00	Wengé					A120W	137,00		A122W	137,00	
6900CPB.2-N	3.864,00	Black					A120N	159,00		A122N	159,00	
6900CPB.2-RAL	4.100,00	RAL					A120RAL	174,00		A122RAL	170,00	
6900CPB.3-R	3.726,00	Oak	CUPBOARD	3x1/1	350W	113x68x144 h	A120R	137,00	1 fixed with tray slide	A123R	170,00	1 drop-down with tray slide
6900CPB.3-W	3.726,00	Wengé					A120W	137,00		A123W	170,00	
6900CPB.3-N	4.286,00	Black					A120N	159,00		A123N	198,00	
6900CPB.3-RAL	4.546,00	RAL					A120RAL	174,00		A123RAL	227,00	
6900CPB.4-R	4.295,00	Oak	CUPBOARD	4x1/1	450W	161x68x144 h	A120R	137,00	1 fixed with tray slide	A124R	208,00	1 drop-down with tray slide
6900CPB.4-W	4.295,00	Wengé					A120W	137,00		A124W	208,00	
6900CPB.4-N	4.940,00	Black					A120N	159,00		A124N	242,00	
6900CPB.4-RAL	5.240,00	RAL					A120RAL	174,00		A124RAL	273,00	
6900CPB.5-R	4.748,00	Oak	CUPBOARD	5x1/1	460W	193x68x144 h	A120R	137,00	1 fixed with tray slide	A125R	273,00	1 drop-down with tray slide
6900CPB.5-W	4.748,00	Wengé					A120W	137,00		A125W	273,00	
6900CPB.5-N	5.459,00	Black					A120N	159,00		A125N	318,00	
6900CPB.5-RAL	5.792,00	RAL					A120RAL	174,00		A125RAL	384,00	
6900CPB.6-R	5.198,00	Oak	CUPBOARD	6x1/1	460W	226x68x144 h	A120R	137,00	1 fixed with tray slide	A126R	311,00	1 drop-down with tray slide
6900CPB.6-W	5.198,00	Wengé					A120W	137,00		A126W	311,00	
6900CPB.6-N	5.977,00	Black					A120N	159,00		A126N	362,00	
6900CPB.6-RAL	6.340,00	RAL					A120RAL	174,00		A126RAL	469,00	

OPTIONAL ITEMS AND ACCESSORIES SUITABLE FOR BOTH VERSIONS

Optional	€	📷	Description	GN	
A142	117,00	1	Front drop-down stainless steel rodded tray slide	2x1/1	
A143	130,00			3x1/1	
A144	166,00			4x1/1	
A145	245,00			5x1/1	
A146	256,00			6x1/1	
Optional	€		Description	Suitable for	
A156	37,00		Drain tap (necessary for fish displaying)	All articles	
Accessories	€	📷	Description	Suitable for	
A10	31,00	2	1/1 GN Flat	All articles	
A20	36,00	3	1/1 GN Perforated		

REFRIGERATED SELF-SERVICE BUFFET TROLLEYS - ADJUSTABLE SNEEZE GUARD - LED LIGHTING

- Stainless steel overhead gantry with led lighting
- Height-adjustable tempered glass sneeze guard
- Plywood panels, shelf (and doors in the cupboard version)
- AISI 304 stainless steel legs, brushed finish
- For BLACK finish: structure in water-repellent MDF with transparent coating
- AISI 304 stainless steel 19 cm-deep well for up to 15 cm-deep GN pans (not included)
- Condensate drain at the base of the well (drain tap available on request)
Note: the drain tap is necessary for fish displaying
- Control panel with digital thermostat-thermometer and ON/OFF switch with warning light
- Mains supply: 230V, 50 Hz (60 Hz upon request), single-phase
- Static refrigeration +4°C +10°C
- Swivel castors ø 12.5 cm, 2 with brake

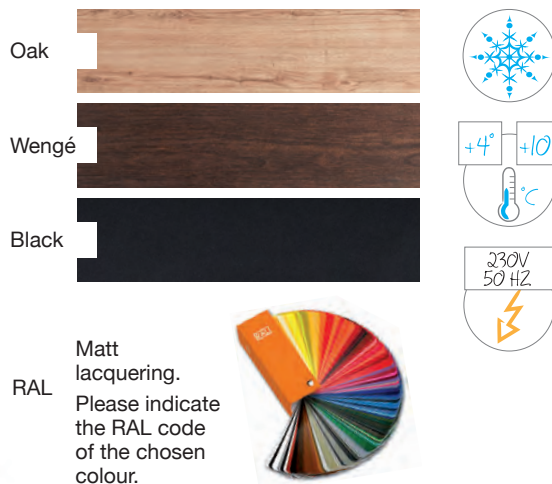

Complementary elements see pp. 70-71

Optional Gastronorms see pp. 132-133

Art. 6900.4M-R + A124R(x2) + pans

OPEN LOWER PART VERSION

Article	€	Finish	Typology	GN	Power	Max dim. cm	Optional	€	Lateral shelf	Optional	€	Front shelf
6900.2M-R	3.197,00	Oak	OPEN LOWER PART	2x1/1	190W	80x68x144 h	A120R	137,00	1 fixed with tray slide	A122R	137,00	1 drop-down with tray slide
6900.2M-W	3.197,00	Wengé					A120W	137,00		A122W	137,00	
6900.2M-N	3.600,00	Black					A120N	159,00		A122N	159,00	
6900.2M-RAL	3.788,00	RAL					A120RAL	174,00		A122RAL	170,00	
6900.3M-R	3.599,00	Oak	OPEN LOWER PART	3x1/1	350W	113x68x144 h	A120R	137,00	1 fixed with tray slide	A123R	170,00	1 drop-down with tray slide
6900.3M-W	3.599,00	Wengé					A120W	137,00		A123W	170,00	
6900.3M-N	4.045,00	Black					A120N	159,00		A123N	198,00	
6900.3M-RAL	4.254,00	RAL					A120RAL	174,00		A123RAL	227,00	
6900.4M-R	4.163,00	Oak	OPEN LOWER PART	4x1/1	450W	161x68x144 h	A120R	137,00	1 fixed with tray slide	A124R	208,00	1 drop-down with tray slide
6900.4M-W	4.163,00	Wengé					A120W	137,00		A124W	208,00	
6900.4M-N	4.678,00	Black					A120N	159,00		A124N	242,00	
6900.4M-RAL	4.919,00	RAL					A120RAL	174,00		A124RAL	273,00	
6900.5M-R	4.634,00	Oak	OPEN LOWER PART	5x1/1	460W	193x68x144 h	A120R	137,00	1 fixed with tray slide	A125R	273,00	1 drop-down with tray slide
6900.5M-W	4.634,00	Wengé					A120W	137,00		A125W	273,00	
6900.5M-N	5.203,00	Black					A120N	159,00		A125N	318,00	
6900.5M-RAL	5.470,00	RAL					A120RAL	174,00		A125RAL	384,00	
6900.6M-R	5.103,00	Oak	OPEN LOWER PART	6x1/1	460W	226x68x144 h	A120R	137,00	1 fixed with tray slide	A126R	311,00	1 drop-down with tray slide
6900.6M-W	5.103,00	Wengé					A120W	137,00		A126W	311,00	
6900.6M-N	5.727,00	Black					A120N	159,00		A126N	362,00	
6900.6M-RAL	6.018,00	RAL					A120RAL	174,00		A126RAL	469,00	

Note: when ordering one single front shelf, it is mounted on the opposite side to the operator one, unless otherwise specified.

REFRIGERATED SELF-SERVICE BUFFET TROLLEYS - ADJUSTABLE SNEEZE GUARD - LED LIGHTING





Art. 6900CPB.3M-N + A123N(x2) + A120N(x2) + pans

CUPBOARD VERSION: with back panel, side panels and doors

Note: when ordering one single front shelf, it is mounted on the opposite side to the operator one, unless otherwise specified.

Article	€	Finish	Typology	GN	Power	Max dim. cm	Optional	€	Lateral shelf	Optional	€	Front shelf
6900CPB.2M-R	3.869,00	Oak	CUPBOARD	2x1/1	190W	80x68x144 h	A120R	137,00	1 fixed with tray slide	A122R	137,00	1 drop-down with tray slide
6900CPB.2M-W	3.869,00	Wengé					A120W	137,00		A122W	137,00	
6900CPB.2M-N	4.373,00	Black					A120N	159,00		A122N	159,00	
6900CPB.2M-RAL	4.608,00	RAL					A120RAL	174,00		A122RAL	170,00	
6900CPB.3M-R	4.343,00	Oak	CUPBOARD	3x1/1	350W	113x68x144 h	A120R	137,00	1 fixed with tray slide	A123R	170,00	1 drop-down with tray slide
6900CPB.3M-W	4.343,00	Wengé					A120W	137,00		A123W	170,00	
6900CPB.3M-N	4.903,00	Black					A120N	159,00		A123N	198,00	
6900CPB.3M-RAL	5.163,00	RAL					A120RAL	174,00		A123RAL	227,00	
6900CPB.4M-R	5.022,00	Oak	CUPBOARD	4x1/1	450W	161x68x144 h	A120R	137,00	1 fixed with tray slide	A124R	208,00	1 drop-down with tray slide
6900CPB.4M-W	5.022,00	Wengé					A120W	137,00		A124W	208,00	
6900CPB.4M-N	5.666,00	Black					A120N	159,00		A124N	242,00	
6900CPB.4M-RAL	5.967,00	RAL					A120RAL	174,00		A124RAL	273,00	
6900CPB.5M-R	5.583,00	Oak	CUPBOARD	5x1/1	460W	193x68x144 h	A120R	137,00	1 fixed with tray slide	A125R	273,00	1 drop-down with tray slide
6900CPB.5M-W	5.583,00	Wengé					A120W	137,00		A125W	273,00	
6900CPB.5M-N	6.295,00	Black					A120N	159,00		A125N	318,00	
6900CPB.5M-RAL	6.628,00	RAL					A120RAL	174,00		A125RAL	384,00	
6900CPB.6M-R	6.143,00	Oak	CUPBOARD	6x1/1	460W	226x68x144 h	A120R	137,00	1 fixed with tray slide	A126R	311,00	1 drop-down with tray slide
6900CPB.6M-W	6.143,00	Wengé					A120W	137,00		A126W	311,00	
6900CPB.6M-N	6.922,00	Black					A120N	159,00		A126N	362,00	
6900CPB.6M-RAL	7.285,00	RAL					A120RAL	174,00		A126RAL	469,00	

OPTIONAL ITEMS AND ACCESSORIES SUITABLE FOR BOTH VERSIONS

Optional	€	📷	Description	GN	
A142	117,00	1	Front drop-down stainless steel rodded tray slide	2x1/1	
A143	130,00			3x1/1	
A144	166,00			4x1/1	
A145	245,00			5x1/1	
A146	256,00			6x1/1	
Optional	€		Description	Suitable for	
A156	37,00		Drain tap (necessary for fish displaying)	All articles	
Accessories	€	📷	Description	Suitable for	
A10	31,00	2	1/1 GN Flat	All articles	
A20	36,00	3	1/1 GN Perforated		

HEATED SELF-SERVICE BUFFET TROLLEYS - FIXED SNEEZE GUARD - LED LIGHTING

- Stainless steel overhead gantry with led lighting
- Fixed plexiglass sneeze guard
- Plywood panels, shelf (and doors in the cupboard version)
- AISI 304 stainless steel legs, brushed finish
- For BLACK finish: structure in water-repellent MDF with transparent coating
- AISI 304 stainless steel 19 cm-deep well for up to 15 cm-deep GN pans (not included)
- Bain-marie drain plug
- Control panel with digital thermostat-thermometer and ON/OFF switch with warning light
- Mains supply: 230V, 50/60 Hz, single-phase
- Bain-marie heating with heating element outside the well
- Dry heating: details and quotes upon request
- Swivel castors ø 12.5 cm, 2 with brake



Art. 6910.4-RAL + A124RAL(x2) + pans

Complementary elements see pp. 70-71

Optional Gastronorms: see pp. 132-133

OPEN LOWER PART VERSION

Article	€	Finish	Typology	GN	Power	Max dim. cm	Optional	€	Lateral shelf	Optional	€	Front shelf
6910.2-R	2.039,00	Oak	OPEN LOWER PART	2x1/1	1200W	80x68x144 h	A120R	137,00	1 fixed with tray slide	A122R	137,00	1 drop-down with tray slide
6910.2-W	2.039,00	Wengé					A120W	137,00		A122W	137,00	
6910.2-N	2.344,00	Black					A120N	159,00		A122N	159,00	
6910.2-RAL	2.487,00	RAL					A120RAL	174,00		A122RAL	170,00	
6910.3-R	2.363,00	Oak	OPEN LOWER PART	3x1/1	1500W	113x68x144 h	A120R	137,00	1 fixed with tray slide	A123R	170,00	1 drop-down with tray slide
6910.3-W	2.363,00	Wengé					A120W	137,00		A123W	170,00	
6910.3-N	2.718,00	Black					A120N	159,00		A123N	198,00	
6910.3-RAL	2.883,00	RAL					A120RAL	174,00		A123RAL	227,00	
6910.4-R	2.751,00	Oak	OPEN LOWER PART	4x1/1	2400W	161x68x144 h	A120R	137,00	1 fixed with tray slide	A124R	208,00	1 drop-down with tray slide
6910.4-W	2.751,00	Wengé					A120W	137,00		A124W	208,00	
6910.4-N	3.164,00	Black					A120N	159,00		A124N	242,00	
6910.4-RAL	3.357,00	RAL					A120RAL	174,00		A124RAL	273,00	
6910.5-R	3.096,00	Oak	OPEN LOWER PART	5x1/1	3000W	193x68x144 h	A120R	137,00	1 fixed with tray slide	A125R	273,00	1 drop-down with tray slide
6910.5-W	3.096,00	Wengé					A120W	137,00		A125W	273,00	
6910.5-N	3.560,00	Black					A120N	159,00		A125N	318,00	
6910.5-RAL	3.776,00	RAL					A120RAL	174,00		A125RAL	384,00	
6910.6-R	3.737,00	Oak	OPEN LOWER PART	6x1/1	3000W	226x68x144 h	A120R	137,00	1 fixed with tray slide	A126R	311,00	1 drop-down with tray slide
6910.6-W	3.737,00	Wengé					A120W	137,00		A126W	311,00	
6910.6-N	4.298,00	Black					A120N	159,00		A126N	362,00	
6910.6-RAL	4.560,00	RAL					A120RAL	174,00		A126RAL	469,00	

Note: when ordering one single front shelf, it is mounted on the opposite side to the operator one, unless otherwise specified.

HEATED SELF-SERVICE BUFFET TROLLEYS - FIXED SNEEZE GUARD - LED LIGHTING





Art. 6910CPB.4-RAL + A124RAL(x2) + pans

CUPBOARD VERSION: with back panel, side panels and doors

Note: when ordering one single front shelf, it is mounted on the opposite side to the operator one, unless otherwise specified.

Article	€	Finish	Typology	GN	Power	Max dim. cm	Optional	€	Lateral shelf	Optional	€	Front shelf
6910CPB.2-R	2.711,00	Oak	CUPBOARD	2x1/1	1200W	80x68x144 h	A120R	137,00	1 fixed with tray slide	A122R	137,00	1 drop-down with tray slide
6910CPB.2-W	2.711,00	Wengé					A120W	137,00		A122W	137,00	
6910CPB.2-N	3.117,00	Black					A120N	159,00		A122N	159,00	
6910CPB.2-RAL	3.307,00	RAL					A120RAL	174,00		A122RAL	170,00	
6910CPB.3-R	3.108,00	Oak	CUPBOARD	3x1/1	1500W	113x68x144 h	A120R	137,00	1 fixed with tray slide	A123R	170,00	1 drop-down with tray slide
6910CPB.3-W	3.108,00	Wengé					A120W	137,00		A123W	170,00	
6910CPB.3-N	3.575,00	Black					A120N	159,00		A123N	198,00	
6910CPB.3-RAL	3.792,00	RAL					A120RAL	174,00		A123RAL	227,00	
6910CPB.4-R	3.610,00	Oak	CUPBOARD	4x1/1	2400W	161x68x144 h	A120R	137,00	1 fixed with tray slide	A124R	208,00	1 drop-down with tray slide
6910CPB.4-W	3.610,00	Wengé					A120W	137,00		A124W	208,00	
6910CPB.4-N	4.152,00	Black					A120N	159,00		A124N	242,00	
6910CPB.4-RAL	4.405,00	RAL					A120RAL	174,00		A124RAL	273,00	
6910CPB.5-R	4.045,00	Oak	CUPBOARD	5x1/1	3000W	193x68x144 h	A120R	137,00	1 fixed with tray slide	A125R	273,00	1 drop-down with tray slide
6910CPB.5-W	4.045,00	Wengé					A120W	137,00		A125W	273,00	
6910CPB.5-N	4.652,00	Black					A120N	159,00		A125N	318,00	
6910CPB.5-RAL	4.934,00	RAL					A120RAL	174,00		A125RAL	384,00	
6910CPB.6-R	4.777,00	Oak	CUPBOARD	6x1/1	3000W	226x68x144 h	A120R	137,00	1 fixed with tray slide	A126R	311,00	1 drop-down with tray slide
6910CPB.6-W	4.777,00	Wengé					A120W	137,00		A126W	311,00	
6910CPB.6-N	5.493,00	Black					A120N	159,00		A126N	362,00	
6910CPB.6-RAL	5.827,00	RAL					A120RAL	174,00		A126RAL	469,00	

OPTIONAL ITEMS AND ACCESSORIES SUITABLE FOR BOTH VERSIONS

Optional	€	📷	Description	GN	
A142	117,00	1	Front drop-down stainless steel rodded tray slide	2x1/1	
A143	130,00			3x1/1	
A144	166,00			4x1/1	
A145	245,00			5x1/1	
A146	256,00			6x1/1	
Optional	€		Description		Suitable for
A152	220,00		Mains supply 380V		All articles
A154	177,00		Water loading from net, drain tap and overflow		
Accessories	€	📷	Description	Suitable for	
A10	31,00	2	1/1 GN Flat	All articles	
A20	36,00	3	1/1 GN Perforated		

HEATED SELF-SERVICE BUFFET TROLLEYS - FIXED SNEEZE GUARD - INFRARED LAMPS

- Stainless steel overhead gantry with upper heating set of infrared lamps
- Fixed plexiglass sneeze guard
- Plywood panels, shelf (and doors in the cupboard version)
- AISI 304 stainless steel legs, brushed finish
- For BLACK finish: structure in water-repellent MDF with transparent coating
- AISI 304 stainless steel 19 cm-deep well for up to 15 cm-deep GN pans (not included)
- Bain-marie drain plug
- Bain-marie heating with heating element outside the well
- Dry heating: details and quotes upon request
- Control panel with digital thermostat-thermometer and ON/OFF switch with warning light
- Mains supply: 230V, 50/60 Hz, single-phase
- Swivel castors ø 12.5 cm, 2 with brake

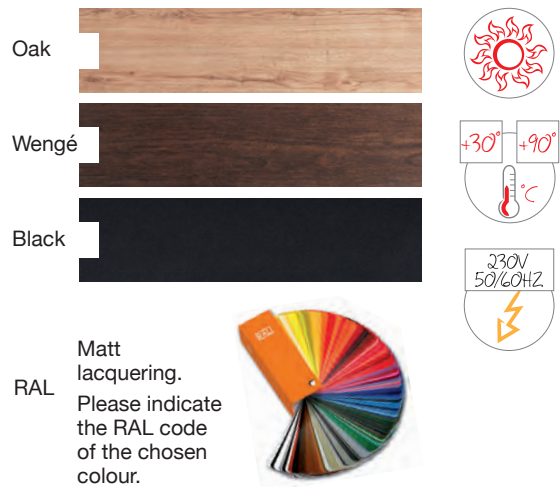

Complementary elements see pp. 70-71

Optional Gastronorms: see pp. 132-133

Art. 6910.4L-W + A124W(x2) + A20(x2) + pans

OPEN LOWER PART VERSION

Article	€	Finish	Typology	GN	Power	Max dim. cm	Optional	€	Lateral shelf	Optional	€	Front shelf
6910.2L-R	2.303,00	Oak	OPEN LOWER PART	2x1/1	1700W	80x68x144 h	A120R	137,00	1 fixed with tray slide	A122R	137,00	1 drop-down with tray slide
6910.2L-W	2.303,00	Wengé					A120W	137,00		A122W	137,00	
6910.2L-N	2.610,00	Black					A120N	159,00		A122N	159,00	
6910.2L-RAL	2.751,00	RAL					A120RAL	174,00		A122RAL	170,00	
6910.3L-R	2.716,00	Oak	OPEN LOWER PART	3x1/1	2250W	113x68x144 h	A120R	137,00	1 fixed with tray slide	A123R	170,00	1 drop-down with tray slide
6910.3L-W	2.716,00	Wengé					A120W	137,00		A123W	170,00	
6910.3L-N	3.071,00	Black					A120N	159,00		A123N	198,00	
6910.3L-RAL	3.236,00	RAL					A120RAL	174,00		A123RAL	227,00	
6910.4L-R	3.242,00	Oak	OPEN LOWER PART	4x1/1	3400W	161x68x144 h	A120R	137,00	1 fixed with tray slide	A124R	208,00	1 drop-down with tray slide
6910.4L-W	3.242,00	Wengé					A120W	137,00		A124W	208,00	
6910.4L-N	3.654,00	Black					A120N	159,00		A124N	242,00	
6910.4L-RAL	3.847,00	RAL					A120RAL	174,00		A124RAL	273,00	
6910.5L-R	3.722,00	Oak	OPEN LOWER PART	5x1/1	4250W	193x68x144 h	A120R	137,00	1 fixed with tray slide	A125R	273,00	1 drop-down with tray slide
6910.5L-W	3.722,00	Wengé					A120W	137,00		A125W	273,00	
6910.5L-N	4.186,00	Black					A120N	159,00		A125N	318,00	
6910.5L-RAL	4.403,00	RAL					A120RAL	174,00		A125RAL	384,00	
6910.6L-R	4.500,00	Oak	OPEN LOWER PART	6x1/1	4500W	226x68x144 h	A120R	137,00	1 fixed with tray slide	A126R	311,00	1 drop-down with tray slide
6910.6L-W	4.500,00	Wengé					A120W	137,00		A126W	311,00	
6910.6L-N	5.060,00	Black					A120N	159,00		A126N	362,00	
6910.6L-RAL	5.322,00	RAL					A120RAL	174,00		A126RAL	469,00	

Note: when ordering one single front shelf, it is mounted on the opposite side to the operator one, unless otherwise specified.

HEATED SELF-SERVICE BUFFET TROLLEYS - FIXED SNEEZE GUARD - INFRARED LAMPS



Art. 6910CPB.4L-W + A124W(x2) + pans





CUPBOARD VERSION: with back panel, side panels and doors

Article	€	Finish	Typology	GN	Power	Max dim. cm	Optional	€	Lateral shelf	Optional	€	Front shelf
6910CPB.2L-R	2.975,00	Oak	CUPBOARD	2x1/1	1700W	80x68x144 h	A120R	137,00	1 fixed with tray slide	A122R	137,00	1 drop-down with tray slide
6910CPB.2L-W	2.975,00	Wengé					A120W	137,00		A122W	137,00	
6910CPB.2L-N	3.383,00	Black					A120N	159,00		A122N	159,00	
6910CPB.2L-RAL	3.572,00	RAL					A120RAL	174,00		A122RAL	170,00	
6910CPB.3L-R	3.461,00	Oak	CUPBOARD	3x1/1	2250W	113x68x144 h	A120R	137,00	1 fixed with tray slide	A123R	170,00	1 drop-down with tray slide
6910CPB.3L-W	3.461,00	Wengé					A120W	137,00		A123W	170,00	
6910CPB.3L-N	3.927,00	Black					A120N	159,00		A123N	198,00	
6910CPB.3L-RAL	4.145,00	RAL					A120RAL	174,00		A123RAL	227,00	
6910CPB.4L-R	4.101,00	Oak	CUPBOARD	4x1/1	3400W	161x68x144 h	A120R	137,00	1 fixed with tray slide	A124R	208,00	1 drop-down with tray slide
6910CPB.4L-W	4.101,00	Wengé					A120W	137,00		A124W	208,00	
6910CPB.4L-N	4.643,00	Black					A120N	159,00		A124N	242,00	
6910CPB.4L-RAL	4.895,00	RAL					A120RAL	174,00		A124RAL	273,00	
6910CPB.5L-R	4.671,00	Oak	CUPBOARD	5x1/1	4250W	193x68x144 h	A120R	137,00	1 fixed with tray slide	A125R	273,00	1 drop-down with tray slide
6910CPB.5L-W	4.671,00	Wengé					A120W	137,00		A125W	273,00	
6910CPB.5L-N	5.278,00	Black					A120N	159,00		A125N	318,00	
6910CPB.5L-RAL	5.561,00	RAL					A120RAL	174,00		A125RAL	384,00	
6910CPB.6L-R	5.539,00	Oak	CUPBOARD	6x1/1	4500W	226x68x144 h	A120R	137,00	1 fixed with tray slide	A126R	311,00	1 drop-down with tray slide
6910CPB.6L-W	5.539,00	Wengé					A120W	137,00		A126W	311,00	
6910CPB.6L-N	6.255,00	Black					A120N	159,00		A126N	362,00	
6910CPB.6L-RAL	6.590,00	RAL					A120RAL	174,00		A126RAL	469,00	

Note: when ordering one single front shelf, it is mounted on the opposite side to the operator one, unless otherwise specified.

OPTIONAL ITEMS AND ACCESSORIES SUITABLE FOR BOTH VERSIONS

Optional	€	📷	Description	GN	
A142	117,00	1	Front drop-down stainless steel rodded tray slide	2x1/1	
A143	130,00			3x1/1	
A144	166,00			4x1/1	
A145	245,00			5x1/1	
A146	256,00			6x1/1	
Optional	€		Description		Suitable for
LB	18,00		White lamps		All articles
A152	220,00		Mains supply 380V		
A154	177,00		Water loading from net, drain tap and overflow		
Accessories	€	📷	Description	Suitable for	
A10	31,00	2	1/1 GN Flat	All articles	
A20	36,00	3	1/1 GN Perforated		

HEATED SELF-SERVICE BUFFET TROLLEYS - ADJUSTABLE SNEEZE GUARD - LED LIGHTING

- Stainless steel overhead gantry with led lighting
- Height-adjustable tempered glass sneeze guard
- Plywood panels, shelf (and doors in the cupboard version)
- AISI 304 stainless steel legs, brushed finish
- For BLACK finish: structure in water-repellent MDF with transparent coating
- AISI 304 stainless steel 19 cm-deep well for up to 15 cm-deep GN pans (not included)
- Bain-marie drain plug
- Bain-marie heating with heating element outside the well
- Dry heating: details and quotes upon request
- Control panel with digital thermostat-thermometer and ON/OFF switch with warning light
- Mains supply: 230V, 50/60 Hz, single-phase
- Swivel castors ø 12.5 cm, 2 with brake



ADJUSTABLE SNEEZE GUARD

Complementary elements see pp. 70-71

Optional Gastronorms: see pp. 132-133

Art. 6910.4M-R + A124R(x2) + pans

OPEN LOWER PART VERSION

Article	€	Finish	Typology	GN	Power	Max dim. cm	Optional	€	Lateral shelf	Optional	€	Front shelf
6910.2M-R	2.547,00	Oak	OPEN LOWER PART	2x1/1	1200W	80x68x144 h	A120R	137,00	1 fixed with tray slide	A122R	137,00	1 drop-down with tray slide
6910.2M-W	2.547,00	Wengé					A120W	137,00		A122W	137,00	
6910.2M-N	2.852,00	Black					A120N	159,00		A122N	159,00	
6910.2M-RAL	2.995,00	RAL					A120RAL	174,00		A122RAL	170,00	
6910.3M-R	2.980,00	Oak	OPEN LOWER PART	3x1/1	1500W	113x68x144 h	A120R	137,00	1 fixed with tray slide	A123R	170,00	1 drop-down with tray slide
6910.3M-W	2.980,00	Wengé					A120W	137,00		A123W	170,00	
6910.3M-N	3.335,00	Black					A120N	159,00		A123N	198,00	
6910.3M-RAL	3.500,00	RAL					A120RAL	174,00		A123RAL	227,00	
6910.4M-R	3.478,00	Oak	OPEN LOWER PART	4x1/1	2400W	161x68x144 h	A120R	137,00	1 fixed with tray slide	A124R	208,00	1 drop-down with tray slide
6910.4M-W	3.478,00	Wengé					A120W	137,00		A124W	208,00	
6910.4M-N	3.891,00	Black					A120N	159,00		A124N	242,00	
6910.4M-RAL	4.084,00	RAL					A120RAL	174,00		A124RAL	273,00	
6910.5M-R	3.932,00	Oak	OPEN LOWER PART	5x1/1	3000W	193x68x144 h	A120R	137,00	1 fixed with tray slide	A125R	273,00	1 drop-down with tray slide
6910.5M-W	3.932,00	Wengé					A120W	137,00		A125W	273,00	
6910.5M-N	4.396,00	Black					A120N	159,00		A125N	318,00	
6910.5M-RAL	4.612,00	RAL					A120RAL	174,00		A125RAL	384,00	
6910.6M-R	4.682,00	Oak	OPEN LOWER PART	6x1/1	3000W	226x68x144 h	A120R	137,00	1 fixed with tray slide	A126R	311,00	1 drop-down with tray slide
6910.6M-W	4.682,00	Wengé					A120W	137,00		A126W	311,00	
6910.6M-N	5.243,00	Black					A120N	159,00		A126N	362,00	
6910.6M-RAL	5.505,00	RAL					A120RAL	174,00		A126RAL	469,00	

Note: when ordering one single front shelf, it is mounted on the opposite side to the operator one, unless otherwise specified.

HEATED SELF-SERVICE BUFFET TROLLEYS - ADJUSTABLE SNEEZE GUARD - LED LIGHTING





Art. 6910CPB.4M-R + A124R(x2) + pans

CUPBOARD VERSION: with back panel, side panels and doors

Note: when ordering one single front shelf, it is mounted on the opposite side to the operator one, unless otherwise specified.

Article	€	Finish	Typology	GN	Power	Max dim. cm	Optional	€	Lateral shelf	Optional	€	Front shelf
6910CPB.2M-R	3.219,00	Oak	CUPBOARD	2x1/1	1200W	80x68x144 h	A120R	137,00	1 fixed with tray slide	A122R	137,00	1 drop-down with tray slide
6910CPB.2M-W	3.219,00	Wengé					A120W	137,00		A122W	137,00	
6910CPB.2M-N	3.625,00	Black					A120N	159,00		A122N	159,00	
6910CPB.2M-RAL	3.815,00	RAL					A120RAL	174,00		A122RAL	170,00	
6910CPB.3M-R	3.726,00	Oak	CUPBOARD	3x1/1	1500W	113x68x144 h	A120R	137,00	1 fixed with tray slide	A123R	170,00	1 drop-down with tray slide
6910CPB.3M-W	3.726,00	Wengé					A120W	137,00		A123W	170,00	
6910CPB.3M-N	4.192,00	Black					A120N	159,00		A123N	198,00	
6910CPB.3M-RAL	4.409,00	RAL					A120RAL	174,00		A123RAL	227,00	
6910CPB.4M-R	4.337,00	Oak	CUPBOARD	4x1/1	2400W	161x68x144 h	A120R	137,00	1 fixed with tray slide	A124R	208,00	1 drop-down with tray slide
6910CPB.4M-W	4.337,00	Wengé					A120W	137,00		A124W	208,00	
6910CPB.4M-N	4.879,00	Black					A120N	159,00		A124N	242,00	
6910CPB.4M-RAL	5.132,00	RAL					A120RAL	174,00		A124RAL	273,00	
6910CPB.5M-R	4.881,00	Oak	CUPBOARD	5x1/1	3000W	193x68x144 h	A120R	137,00	1 fixed with tray slide	A125R	273,00	1 drop-down with tray slide
6910CPB.5M-W	4.881,00	Wengé					A120W	137,00		A125W	273,00	
6910CPB.5M-N	5.488,00	Black					A120N	159,00		A125N	318,00	
6910CPB.5M-RAL	5.770,00	RAL					A120RAL	174,00		A125RAL	384,00	
6910CPB.6M-R	5.722,00	Oak	CUPBOARD	6x1/1	3000W	226x68x144 h	A120R	137,00	1 fixed with tray slide	A126R	311,00	1 drop-down with tray slide
6910CPB.6M-W	5.722,00	Wengé					A120W	137,00		A126W	311,00	
6910CPB.6M-N	6.438,00	Black					A120N	159,00		A126N	362,00	
6910CPB.6M-RAL	6.772,00	RAL					A120RAL	174,00		A126RAL	469,00	

OPTIONAL ITEMS AND ACCESSORIES SUITABLE FOR BOTH VERSIONS

Optional	€	📷	Description	GN	
A142	117,00	1	Front drop-down stainless steel rodded tray slide	2x1/1	
A143	130,00			3x1/1	
A144	166,00			4x1/1	
A145	245,00			5x1/1	
A146	256,00			6x1/1	
Optional	€		Description		Suitable for
A152	220,00		Mains supply 380V		All articles
A154	177,00		Water loading from net, drain tap and overflow		
Accessories	€	📷	Description	Suitable for	
A10	31,00	2	1/1 GN Flat	All articles	
A20	36,00	3	1/1 GN Perforated		

MIXED HOT/COLD SELF-SERVICE BUFFET TROLLEYS - FIXED SNEEZE GUARD - LED LIGHTING

- Stainless steel overhead gantry with led lighting
- Fixed plexiglass sneeze guard
- Plywood panels, shelf (and doors in the cupboard version)
- AISI 304 stainless steel legs, brushed finish
- For BLACK finish: structure in water-repellent MDF with transparent coating
- AISI 304 stainless steel 19 cm-deep well for up to 15 cm-deep GN pans (not included)
- Bain-marie drain tap for the heated part and condensate drip tray inside the compressor compartment for the refrigerated part (with tap available on request)
- Bain-marie heating with heating element outside the well (heated wells)
- Dry heating: details and quotes upon request (heated wells)
- Static refrigeration +4°C +10°C (cold wells)
- Control panel with digital thermostat-thermometer and ON/OFF switch with warning light
- Mains supply: 230V, 50 Hz (60 Hz, upon request) single-phase
- Swivel castors ø 12.5 cm, 2 with brake

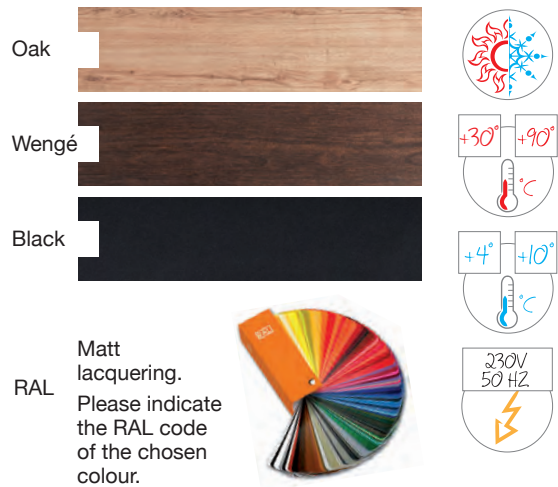

Art. 6920.6F3-W + A126W(x2) + A20(x6)

Complementary elements see pp. 70-71

Optional Gastronorms: see pp. 132-133

OPEN LOWER PART VERSION

Article	€	Finish	Typology	GN compartments	Power	Max dim. cm	Optional	€	Lateral shelf	Optional	€	Front shelf
6920.4F2-R	3.738,00	Oak	OPEN LOWER PART	2 hot + 2 cold	1390W	161x68x144 h	A120R	137,00	1 fixed with tray slide	A124R	208,00	1 drop-down with tray slide
6920.4F2-W	3.738,00	Wengé					A120W	137,00		A124W	208,00	
6920.4F2-N	4.299,00	Black					A120N	159,00		A124N	242,00	
6920.4F2-RAL	4.561,00	RAL					A120RAL	174,00		A124RAL	273,00	
6920.5F2-R	4.089,00	Oak	OPEN LOWER PART	3 hot + 2 cold	1690W	193x68x144 h	A120R	137,00	1 fixed with tray slide	A125R	273,00	1 drop-down with tray slide
6920.5F2-W	4.089,00	Wengé					A120W	137,00		A125W	273,00	
6920.5F2-N	4.703,00	Black					A120N	159,00		A125N	318,00	
6920.5F2-RAL	4.989,00	RAL					A120RAL	174,00		A125RAL	384,00	
6920.5F3-R	4.058,00	Oak	OPEN LOWER PART	2 hot + 3 cold	1550W	193x68x144 h	A120R	137,00	1 fixed with tray slide	A125R	273,00	1 drop-down with tray slide
6920.5F3-W	4.058,00	Wengé					A120W	137,00		A125W	273,00	
6920.5F3-N	4.666,00	Black					A120N	159,00		A125N	318,00	
6920.5F3-RAL	4.950,00	RAL					A120RAL	174,00		A125RAL	384,00	
6920.6F3-R	4.402,00	Oak	OPEN LOWER PART	3 hot + 3 cold	1850W	226x68x144 h	A120R	137,00	1 fixed with tray slide	A126R	311,00	1 drop-down with tray slide
6920.6F3-W	4.402,00	Wengé					A120W	137,00		A126W	311,00	
6920.6F3-N	5.063,00	Black					A120N	159,00		A126N	362,00	
6920.6F3-RAL	5.370,00	RAL					A120RAL	174,00		A126RAL	469,00	

Note: when ordering one single front shelf, it is mounted on the opposite side to the operator one, unless otherwise specified.

MIXED HOT/COLD SELF-SERVICE BUFFET TROLLEYS - FIXED SNEEZE GUARD - LED LIGHTING



Art. 6920CPB.6F3-W + A126W(x2) + A20(x6)



CUPBOARD VERSION: with back panel, side panels and doors

Note: when ordering one single front shelf, it is mounted on the opposite side to the operator one, unless otherwise specified.

Article	€	Finish	Typology	GN compartments	Power	Max dim. cm	Optional	€	Lateral shelf	Optional	€	Front shelf
6920CPB.4F2-R	4.597,00	Oak	CUPBOARD	2 hot + 2 cold	1390W	161x68x144 h	A120R	137,00	1 fixed with tray slide	A124R	208,00	1 drop-down with tray slide
6920CPB.4F2-W	4.597,00	Wengé					A120W	137,00		A124W	208,00	
6920CPB.4F2-N	5.287,00	Black					A120N	159,00		A124N	242,00	
6920CPB.4F2-RAL	5.609,00	RAL					A120RAL	174,00		A124RAL	273,00	
6920CPB.5F2-R	5.039,00	Oak	CUPBOARD	3 hot + 2 cold	1690W	193x68x144 h	A120R	137,00	1 fixed with tray slide	A125R	273,00	1 drop-down with tray slide
6920CPB.5F2-W	5.039,00	Wengé					A120W	137,00		A125W	273,00	
6920CPB.5F2-N	5.794,00	Black					A120N	159,00		A125N	318,00	
6920CPB.5F2-RAL	6.147,00	RAL					A120RAL	174,00		A125RAL	384,00	
6920CPB.5F3-R	5.007,00	Oak	CUPBOARD	2 hot + 3 cold	1550W	193x68x144 h	A120R	137,00	1 fixed with tray slide	A125R	273,00	1 drop-down with tray slide
6920CPB.5F3-W	5.007,00	Wengé					A120W	137,00		A125W	273,00	
6920CPB.5F3-N	5.758,00	Black					A120N	159,00		A125N	318,00	
6920CPB.5F3-RAL	6.108,00	RAL					A120RAL	174,00		A125RAL	384,00	
6920CPB.6F3-R	5.442,00	Oak	CUPBOARD	3 hot + 3 cold	1850W	226x68x144 h	A120R	137,00	1 fixed with tray slide	A126R	311,00	1 drop-down with tray slide
6920CPB.6F3-W	5.442,00	Wengé					A120W	137,00		A126W	311,00	
6920CPB.6F3-N	6.257,00	Black					A120N	159,00		A126N	362,00	
6920CPB.6F3-RAL	6.639,00	RAL					A120RAL	174,00		A126RAL	469,00	

OPTIONAL ITEMS AND ACCESSORIES SUITABLE FOR BOTH VERSIONS

Optional	€	Image	Description	GN	Suitable for
A144	166,00	1	Front drop-down stainless steel rodded tray slide	4x1/1	All articles
A145	245,00			5x1/1	
A146	256,00			6x1/1	
A156	37,00		Drain tap (necessary for fish displaying)		All articles
Accessories	€	Image	Description	Suitable for	Image
A10	31,00	2	1/1 GN Flat	All articles	
A20	36,00	3	1/1 GN Perforated		

MIXED HOT/COLD SELF-SERVICE BUFFET TROLLEYS - ADJUSTABLE SNEEZE GUARD - LED LIGHTING

- Stainless steel overhead gantry with led lighting
- Height-adjustable tempered glass sneeze guard
- Plywood panels, shelf (and doors in the cupboard version)
- AISI 304 stainless steel legs, brushed finish
- For BLACK finish: structure in water-repellent MDF with transparent coating
- AISI 304 stainless steel 19 cm-deep well for up to 15 cm-deep GN pans (not included)
- Bain-marie drain tap for the heated part and condensate drip tray inside the compressor compartment for the refrigerated part (with tap available on request)
- Bain-marie heating with heating element outside the well (heated wells)
- Dry heating: details and quotes upon request (heated wells)
- Static refrigeration +4°C +10°C (cold wells)
- Control panel with digital thermostat-thermometer and ON/OFF switch with warning light
- Mains supply: 230V, 50 Hz (60 Hz upon request), single-phase
- Swivel castors ø 12.5 cm, 2 with brake

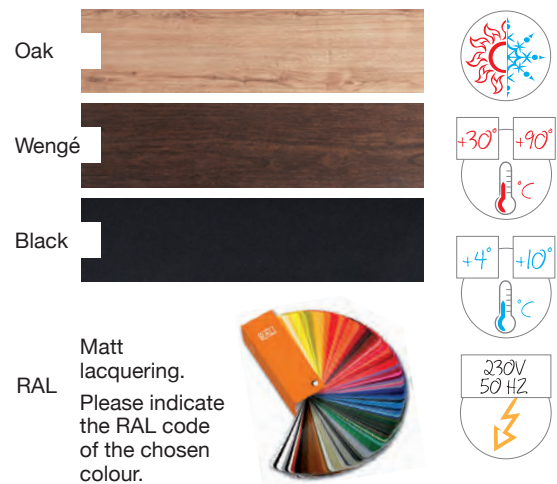

Art. 6920.6F3M-W + A126W(x2) + pans

Complementary elements see pp. 70-71

Optional Gastronorms: see pp. 132-133

OPEN LOWER PART VERSION

Article	€	Finish	Typology	GN compartments	Power	Max dim. cm	Optional	€	Lateral shelf	Optional	€	Front shelf
6920.4F2M-R	4.465,00	Oak	OPEN LOWER PART	2 hot + 2 cold	1390W	161x68x144 h	A120R	137,00	1 fixed with tray slide	A124R	208,00	1 drop-down with tray slide
6920.4F2M-W	4.465,00	Wengé					A120W	137,00		A124W	208,00	
6920.4F2M-N	5.026,00	Black					A120N	159,00		A124N	242,00	
6920.4F2M-RAL	5.287,00	RAL					A120RAL	174,00		A124RAL	273,00	
6920.5F2M-R	4.925,00	Oak	OPEN LOWER PART	3 hot + 2 cold	1690W	193x68x144 h	A120R	137,00	1 fixed with tray slide	A125R	273,00	1 drop-down with tray slide
6920.5F2M-W	4.925,00	Wengé					A120W	137,00		A125W	273,00	
6920.5F2M-N	5.539,00	Black					A120N	159,00		A125N	318,00	
6920.5F2M-RAL	5.825,00	RAL					A120RAL	174,00		A125RAL	384,00	
6920.5F3M-R	4.893,00	Oak	OPEN LOWER PART	2 hot + 3 cold	1550W	193x68x144 h	A120R	137,00	1 fixed with tray slide	A125R	273,00	1 drop-down with tray slide
6920.5F3M-W	4.893,00	Wengé					A120W	137,00		A125W	273,00	
6920.5F3M-N	5.501,00	Black					A120N	159,00		A125N	318,00	
6920.5F3M-RAL	5.786,00	RAL					A120RAL	174,00		A125RAL	384,00	
6920.6F3M-R	5.347,00	Oak	OPEN LOWER PART	3 hot + 3 cold	1850W	226x68x144 h	A120R	137,00	1 fixed with tray slide	A126R	311,00	1 drop-down with tray slide
6920.6F3M-W	5.347,00	Wengé					A120W	137,00		A126W	311,00	
6920.6F3M-N	6.008,00	Black					A120N	159,00		A126N	362,00	
6920.6F3M-RAL	6.315,00	RAL					A120RAL	174,00		A126RAL	469,00	

Note: when ordering one single front shelf, it is mounted on the opposite side to the operator one, unless otherwise specified.

MIXED HOT/COLD SELF-SERVICE BUFFET TROLLEYS - ADJUSTABLE SNEEZE GUARD - LED LIGHTING



Art. 6920CPB.6F3M-W + A126W(x2) + pans





CUPBOARD VERSION: with back panel, side panels and doors

Note: when ordering one single front shelf, it is mounted on the opposite side to the operator one, unless otherwise specified.

Article	€	Finish	Typology	GN compartments	Power	Max dim. cm	Optional	€	Lateral shelf	Optional	€	Front shelf
6920CPB.4F2M-R	5.324,00	Oak	CUPBOARD	2 hot + 2 cold	1390W	161x68x144 h	A120R	137,00	1 fixed with tray slide	A124R	208,00	1 drop-down with tray slide
6920CPB.4F2M-W	5.324,00	Wengé					A120W	137,00		A124W	208,00	
6920CPB.4F2M-N	6.014,00	Black					A120N	159,00		A124N	242,00	
6920CPB.4F2M-RAL	6.335,00	RAL					A120RAL	174,00		A124RAL	273,00	
6920CPB.5F2M-R	5.875,00	Oak	CUPBOARD	3 hot + 2 cold	1690W	193x68x144 h	A120R	137,00	1 fixed with tray slide	A125R	273,00	1 drop-down with tray slide
6920CPB.5F2M-W	5.875,00	Wengé					A120W	137,00		A125W	273,00	
6920CPB.5F2M-N	6.630,00	Black					A120N	159,00		A125N	318,00	
6920CPB.5F2M-RAL	6.983,00	RAL					A120RAL	174,00		A125RAL	384,00	
6920CPB.5F3M-R	5.843,00	Oak	CUPBOARD	2 hot + 3 cold	1550W	193x68x144 h	A120R	137,00	1 fixed with tray slide	A125R	273,00	1 drop-down with tray slide
6920CPB.5F3M-W	5.843,00	Wengé					A120W	137,00		A125W	273,00	
6920CPB.5F3M-N	6.593,00	Black					A120N	159,00		A125N	318,00	
6920CPB.5F3M-RAL	6.944,00	RAL					A120RAL	174,00		A125RAL	384,00	
6920CPB.6F3M-R	6.387,00	Oak	CUPBOARD	3 hot + 3 cold	1850W	226x68x144 h	A120R	137,00	1 fixed with tray slide	A126R	311,00	1 drop-down with tray slide
6920CPB.6F3M-W	6.387,00	Wengé					A120W	137,00		A126W	311,00	
6920CPB.6F3M-N	7.202,00	Black					A120N	159,00		A126N	362,00	
6920CPB.6F3M-RAL	7.584,00	RAL					A120RAL	174,00		A126RAL	469,00	

OPTIONAL ITEMS AND ACCESSORIES SUITABLE FOR BOTH VERSIONS

Optional	€	Image	Description	GN	
A144	166,00	1	Front drop-down stainless steel rodded tray slide	4x1/1	
A145	245,00			5x1/1	
A146	256,00			6x1/1	
Optional	€		Description		Suitable for
A156	37,00		Drain tap (necessary for fish displaying)		All articles
Accessories	€	Image	Description	Suitable for	
A10	31,00	2	1/1 GN Flat	All articles	
A20	36,00	3	1/1 GN Perforated		

COMPLEMENTARY ELEMENTS FOR SELF-SERVICE BUFFET TROLLEYS

- AISI 304 stainless steel legs, brushed finish
- Plywood panels
- For BLACK finish: structure in water-repellent MDF with transparent coating
- Swivel castors \varnothing 12.5 cm, 2 with brake



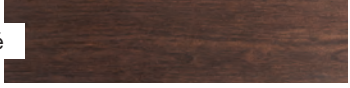

Oak 

Wengé 

Black 

Matt lacquering. Please indicate the RAL code of the chosen colour. 

RAL

Art. 6900.A05W



Art. 6900.A10W



Art. 6900.A01W



Art. 6900.A05W+6910CPB.3L-W

COMPLEMENTARY ELEMENTS FOR SELF-SERVICE BUFFET TROLLEYS



Article				€	Description	Max dim. cm
Oak	Wengé	Black	RAL			
6900.A01R	6900.A01W			784,00	3-Shelf corner trolley	68x68x88 h
		6900.A01N		874,00		
			6900.A01RAL	1.144,00		
6900.A05R	6900.A05W			1.511,00	Trolley with door and open lower part	100x68x88 h
		6900.A05N		1.601,00		
			6900.A05RAL	1.871,00		
6900.A10R	6900.A10W			1.900,00	Neutral plate lowerator for plates ø 18÷28 cm	100x68x88 h
		6900.A10N		1.990,00		
			6900.A10RAL	2.260,00		
6900.A12R	6900.A12W			1.940,00	Neutral plate lowerator for plates ø 28÷32 cm	100x68x88 h
		6900.A12N		2.030,00		
			6900.A12RAL	2.300,00		
6900.A14R	6900.A14W			2.255,00	Heated plate lowerator (600W) for plates ø 18÷28 cm	100x68x88 h
		6900.A14N		2.345,00		
			6900.A14RAL	2.615,00		
6900.A16R	6900.A16W			2.305,00	Heated plate lowerator (600W) for plates ø 28÷32 cm	100x68x88 h
		6900.A16N		2.395,00		
			6900.A16RAL	2.665,00		

Optional	€	Description	Finish	Suitable for
A128R	170,00	Front drop-down shelf with tray slide	Oak	6900.A05R - 6900.A10R - 6900.A12R 6900.A14R - 6900.A16R
A128W	170,00		Wengé	6900.A05W - 6900.A10W - 6900.A12W 6900.A14W - 6900.A16W
A128N	198,00		Black	6900.A05N - 6900.A10N - 6900.A12N 6900.A14N - 6900.A16N
A128RAL	227,00		RAL	6900.A05RAL - 6900.A10RAL - 6900.A12RAL 6900.A14RAL - 6900.A16RAL
A148	130,00	Front drop-down stainless steel rodded shelf	-	For all items except for 3-shelf corner trolleys

REFRIGERATED DROP-IN WITH SNEEZE GUARD

- AISI 304 stainless steel overhead gantry with fixed plexiglass sneeze guard or height-adjustable in tempered glass, led lighting
- AISI 304 stainless steel 19 cm-deep well for up to 15 cm-deep GN pans (not included)
- Drain at the base of well and condensate drip tray or external drain with tap (optional)
- Control panel with digital thermostat-thermometer and ON/OFF switch with warning light
- Mains supply: 230V, single-phase - 50 Hz (60 Hz upon request)
- Static refrigeration +4°C +10°C

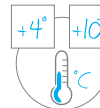

Optional Gastronorms: see pp. 132-133



Art. 6980.4 + A20(x4)

Article	€	GN	Sneeze guard	Lighting	Power	Max dim. cm
6980.2	2.093,00	2x1/1	Fixed	Led	190W	80x68x111 h
6980.3	2.270,00	3x1/1			350W	113x68x111 h
6980.4	2.607,00	4x1/1			450W	161x68x111 h
6980.5	2.828,00	5x1/1			460W	193x68x111 h
6980.6	3.074,00	6x1/1			460W	226x68x111 h
6980.2M	2.601,00	2x1/1			Adjustable	Led
6980.3M	2.887,00	3x1/1	350W	113x68x111 h		
6980.4M	3.333,00	4x1/1	450W	161x68x111 h		
6980.5M	3.664,00	5x1/1	460W	193x68x111 h		
6980.6M	4.019,00	6x1/1	460W	226x68x111 h		

Optional	€	📷	Description	Suitable for
A156	37,00	-	Drain tap	All articles
A10	31,00	1	1/1 GN flat	
A20	36,00	2	1/1 GN perforated	

- AISI 304 stainless steel 19 cm-deep well for up to 15 cm-deep GN pans (not included)
- Drain at the base of well and condensate drip tray or external drain with tap (optional)
- Control panel with digital thermostat-thermometer and ON/OFF switch with warning light

- Mains supply: 230V, single-phase - 50/50 Hz (60 Hz upon request)
- Static refrigeration +4°C +10°C

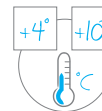

Optional Gastronorms: see pp. 132-133

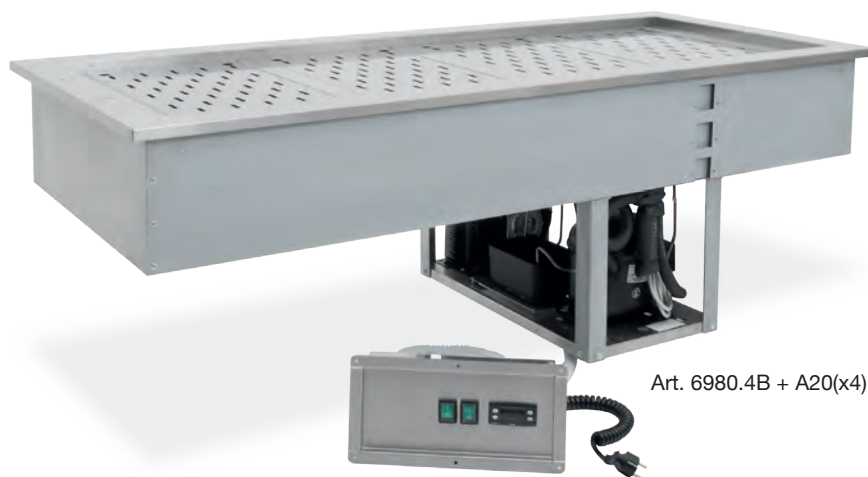

Art. 6980.4B + A20(x4)

Article	€	GN	Description	Power	Max dim. cm
6980.2B	1.558,00	2x1/1	Well only	190W	80x68x55 h
6980.3B	1.696,00	3x1/1		350W	113x68x55 h
6980.4B	1.963,00	4x1/1		450W	161x68x55 h
6980.5B	2.119,00	5x1/1		460W	193x68x55 h
6980.6B	2.298,00	6x1/1		460W	226x68x55 h



Art. A10

1



Art. A20

2

Optional	€	📷	Description	Suitable for
A156	37,00	-	Drain tap	All articles
A10	31,00	1	1/1 GN flat	
A20	36,00	2	1/1 GN perforated	

HEATED DROP-IN WITH SNEEZE GUARD

- AISI 304 stainless steel overhead gantry, with fixed plexiglass sneeze guard or height-adjustable in tempered glass
- Led lighting or heating set of infrared lamps with red light (white light on request)
- AISI 304 stainless steel 19 cm-deep well for up to 15 cm-deep GN pans (not included)
- Drain at base (optional water loading from net and overflow)

- Bain-marie heating with heating element outside the well
- Dry heating: details and quotes upon request
- Control panel with digital thermostat-thermometer and ON/OFF switch with warning light
- Mains supply: 230V, - 50/60 Hz, single-phase (optional 380V three-phase)

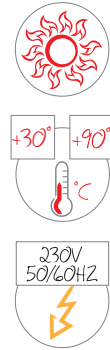

Optional Gastronorms: see pp. 132-133



Art. 6990.4 + A20(x4)

Article	€	GN	Sneeze guard	Lighting	Power	Max dim. cm
6990.2	1.582,00	2x1/1	Fixed	Led	1200W	80x68x78 h
6990.3	1.832,00	3x1/1			1500W	113x68x78 h
6990.4	2.145,00	4x1/1			2400W	161x68x78 h
6990.5	2.485,00	5x1/1			3000W	193x68x78 h
6990.6	2.862,00	6x1/1			3000W	226x68x78 h
6990.2M	2.090,00	2x1/1			Adjustable	Led
6990.3M	2.449,00	3x1/1	1500W	113x68x78 h		
6990.4M	2.871,00	4x1/1	2400W	161x68x78 h		
6990.5M	3.321,00	5x1/1	3000W	193x68x78 h		
6990.6M	3.807,00	6x1/1	3000W	226x68x78 h		
6990.2L	1.846,00	2x1/1	Fixed	Infrared		
6990.3L	2.184,00	3x1/1			1500W	113x68x78 h
6990.4L	2.634,00	4x1/1			2400W	161x68x78 h
6990.5L	3.111,00	5x1/1			3000W	193x68x78 h
6990.6L	3.624,00	6x1/1			3000W	226x68x78 h

Optional	€	📷	Description	Suitable for
A152	220,00	-	Mains supply 380V	All articles
A154	177,00	-	Water loading from net, drain tap and overflow	
A10	31,00	1	GN 1/1 flat	
A20	36,00	2	GN 1/1 perforated	
LB	18,00	-	White lamps	6990.2L - 6990.3L - 6990.4L 6990.5L - 6990.6L

- AISI 304 stainless steel 19 cm-deep well for up to 15 cm-deep GN pans (not included)
 - Drain at base (optional water loading from net and overflow)
 - Control panel with digital thermostat-thermometer and ON/OFF switch
 - Mains supply: 230V, - 50/60 Hz,
- single-phase (optional 380V three-phase)
 - Bain-marie heating with heating element outside the well (heated compartments)
 - Dry heating: details and quotes upon request (heated compartments)

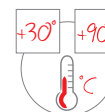

Optional Gastronorms: see pp. 132-133



Art. 6990.4B + A20(x4)

Article	€	GN	Description	Power	Max dim. cm
6990.2B	1.046,00	2x1/1	Well only	1200W	80x68x22 h
6990.3B	1.257,00	3x1/1		1500W	113x68x22 h
6990.4B	1.501,00	4x1/1		2400W	161x68x22 h
6990.5B	1.776,00	5x1/1		3000W	193x68x22 h
6990.6B	2.086,00	6x1/1		3000W	226x68x22 h

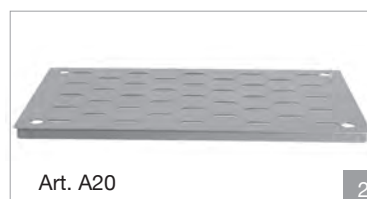
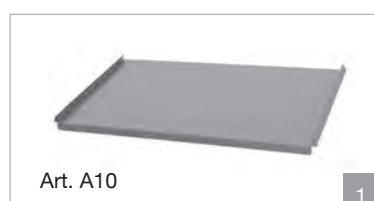











Optional	€	📷	Description	Suitable for
A152	220,00	-	Mains supply 380V	All articles
A154	177,00	-	Water loading from net, drain tap and overflow	
A10	31,00	1	GN 1/1 flat	
A20	36,00	2	GN 1/1 perforated	





Breakfast trolleys
Units for meal distribution
Conveyor belt
Dispensers for glasses, trays, plates and racks
Bain-Marie and Refrigerated trolleys
Heated and refrigerated pan cupboard trolleys

	BREAKFAST TROLLEYS _____	78
	UNITS FOR MEAL DISTRIBUTION _____	80
	CONVEYOR BELT _____	82
	GLASS DISPENSERS AND LOWERATORS _____	84
	TRAY DISPENSERS _____	85
	PLATE DISPENSERS AND LOWERATORS _____	86
	RACK LOWERATORS _____	88
	STAINLESS STEEL BAIN-MARIE TROLLEYS _____	90
	STAINLESS STEEL REFRIGERATED TROLLEYS _____	91
	HEATED AND REFRIGERATED PAN CUPBOARD TROLLEYS _____	92

BREAKFAST TROLLEY for food distribution with 1/1 GN trays

- AISI 304 stainless steel structure, brushed finish
- 2 compartments with 8 pairs of "C"-shaped runners, 8 cm runner-spacing, for 1/1 GN trays and pans
- 270° opening front hinged doors with magnets (to keep the doors open)
- Snap closure handle, optional with lock
- Pushing handles on 2 sides
- Back rail on the top shelf
- Grey rubber all-round bumper
- Non-marking rubber swivel castors, ø cm 12.5, 2 with brake



Art. 7450



"C" shaped runners



Drip tray (A050R)

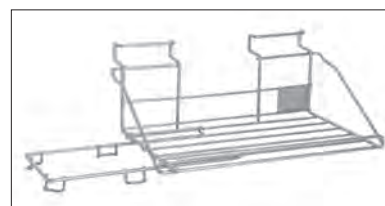

Removable tray shelf (A050M)

Article	€	Left compartment	Right compartment	Max dim. cm
7450	2.700,00	8 pairs of "C"-shaped runners, 8 cm runner-spacing, for 1/1 GN trays and pans	8 pairs of "C"-shaped runners, 8 cm runner-spacing, for 1/1 GN trays and pans	104x76x99 h
Accessories		Description		
A050M	275,00	Removable tray shelf		
A050R	275,00	Drip tray to be placed on the upper shelf		
Optional		Description		
MA	101,00	Closure handle with lock		

BREAKFAST TROLLEY for multi-service distribution

- AISI 304 stainless steel structure, brushed finish
- Left compartment : 5 pairs of "L"-shaped runners, 12 cm runner-spacing, for 50x50 cm dishwashing racks
- Right compartment : 8 pairs of "C"-shaped runners, 8 cm runner-spacing, for 1/1 GN trays and pans
- 270° opening front hinged doors with magnets (to keep the doors open)
- Snap closure handle, optional with lock
- Pushing handles on 2 sides
- Back rail on the top shelf
- Grey rubber all-round bumper
- Non-marking rubber swivel castors, ø cm 12.5, 2 with brake



Art. 7460

customizable

Customizable water-proof
UV-resistant digital print
Please note: the file containing the
image should be provided by you
Quotes upon request

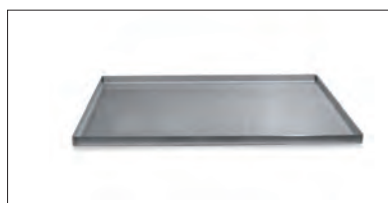

Drip tray (A050C)
to be placed at the bottom of the left
compartment



Drip tray (A051R)

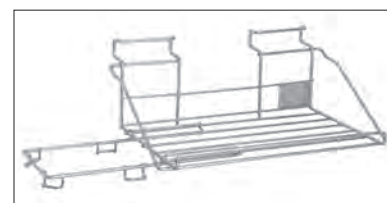

Removable tray shelf (A050M)

Article	€	Left compartment	Right compartment	Max dim. cm
7460	2,825,00	5 pairs of "L"-shaped runners, 12 cm runner-spacing, for 50x50 cm dishwashing racks	8 pairs of "C"-shaped runners, 8 cm runner-spacing, for 1/1 GN trays and pans	125x76x99 h

Accessories	€	Description
A050C	175,00	Stainless steel drip tray to be placed at the bottom of the left compartment
A050M	275,00	Removable tray shelf
A051R	275,00	Drip tray to be placed on the upper shelf

Optional	€	Description
MA	101,00	Closure handle with lock

BAIN-MARIE, REFRIGERATED AND NEUTRAL GN UNITS FOR MEAL DISTRIBUTION

NEUTRAL

- AISI 304 stainless steel sheet cupboard structure, brushed finish
- Glass sneeze guard with standard or "kid-service" opening (depending on the model)
- Stainless steel rodded tray slide
- Flat shelf
- For "COUNTER" service version without sneeze guard, with tray slide
- Adjustable feet, optional swivel castors, 2 with brake

REFRIGERATED

- AISI 304 stainless steel sheet cupboard structure, brushed finish
- Glass sneeze guard with standard or "kid-service" opening (depending on the model)
- Stainless steel rodded tray slide
- Static refrigeration +4°C +10°C
- AISI 304 stainless steel well for up to 20 cm-deep GN pans (not included)
- Hole at the bottom of the well with tap
- Control panel with digital thermostat-thermometer and ON/OFF switch with warning light
- Mains supply 230V, single-phase, 50Hz (60Hz upon request)
- Shelves and control panel at the base of the trolley on operator side
- Adjustable feet, optional swivel castors, 2 with brake

HEATED

- AISI 304 stainless steel sheet cupboard structure, brushed finish
- Glass sneeze guard with standard or "kid-service" opening (depending on the model)
- Stainless steel rodded tray slide
- AISI 304 stainless steel well for up to 20 cm-deep GN pans (not included)
- Bain-marie heating with heating element outside the well
- Dry heating: details and quotes upon request
- Hole at the bottom of the well with drain tap
- Control panel with digital thermostat-thermometer and ON/OFF switch with warning light
- Mains supply 230V, single-phase, 50/60Hz
- Shelves and control panel at the base of the trolley on operator side
- Adjustable feet, optional swivel castors, 2 with brake

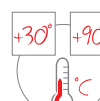
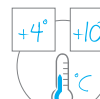

Optional Gastronorms: see pp. 132-133

STANDARD SNEEZE GUARD VERSION

Article	€	Typology	GN	Power	Max dim. cm
6702N	2.247,00		2x1/1	-	82x94x120 h
6703N	2.389,00		3x1/1		120x94x120 h
6704N	2.672,00		4x1/1		158x94x120 h
6702F	4.131,00		2x1/1	361W	82x94x120 h
6703F	4.401,00		3x1/1	416W	120x94x120 h
6704F	4.928,00		4x1/1	543W	158x94x120 h
6702C	3.093,00		2x1/1	1200W	82x94x120 h
6703C	3.623,00		3x1/1	1500W	120x94x120 h
6704C	4.152,00		4x1/1	2400W	158x94x120 h

"KID-SERVICE" OPENING SNEEZE GUARD VERSION

Article	€	Typology	GN	Description	Power	Max dim. cm
6702NH	2.299,00		2x1/1	Glass sneeze guard with "kid-service opening"	-	82x94x133 h
6703NH	2.441,00		3x1/1			120x94x133 h
6704NH	2.723,00		4x1/1			158x94x133 h
6702FH	4.183,00		2x1/1	Glass sneeze guard with "kid-service opening"	361W	82x94x133 h
6703FH	4.452,00		3x1/1		416W	120x94x133 h
6704FH	4.980,00		4x1/1		543W	158x94x133 h
6702CH	3.144,00		2x1/1	Glass sneeze guard with "kid-service opening"	1200W	82x94x133 h
6703CH	3.674,00		3x1/1		1500W	120x94x133 h
6704CH	4.203,00		4x1/1		2400W	158x94x133 h



Art. 6704FH-RM+pans



Art. 6704F+pans

Art. 6703N-P-RM

NO SNEEZE GUARD VERSION

Article	€	Typology	GN	Max dim. cm
6702N-P	1.773,00	⊖	2x1/1	82x94x83 h
6703N-P	1.892,00		3x1/1	120x94x83 h
6704N-P	2.110,00		4x1/1	158x94x83 h

OPTIONAL ITEMS AND ACCESSORIES SUITABLE FOR ALL VERSIONS BOTH WITH AND WITHOUT SNEEZE GUARD

Optional	€	📷	Description	Suitable for	
RM	54,00	1	Set with 4 swivel castors ø 12.5 cm, 2 with brake (as alternative to the feet) and pushing handle	All articles	1
Accessories	€	📷	Description	Suitable for	
A10	31,00	2	1/1 GN Flat	All articles	
A20	36,00	3	1/1 GN Perforated		

CONVEYOR BELT

- AISI 304 stainless steel structure, brushed finish
- On adjustable feet
- Belt suitable for direct contact with food, belt width 30 cm
- Moisture-proof polyurethane cords, spaced 20 cm apart
- Available in lengths from 3 to 10 meters
- Main switch
- ON/OFF switch
- 2 emergency stop buttons
- Mechanical end stop
- Adjustable speed
- Wood cage packaging
- Mains supply 400V/50Hz 3Ph+N+E - Kw 0,37

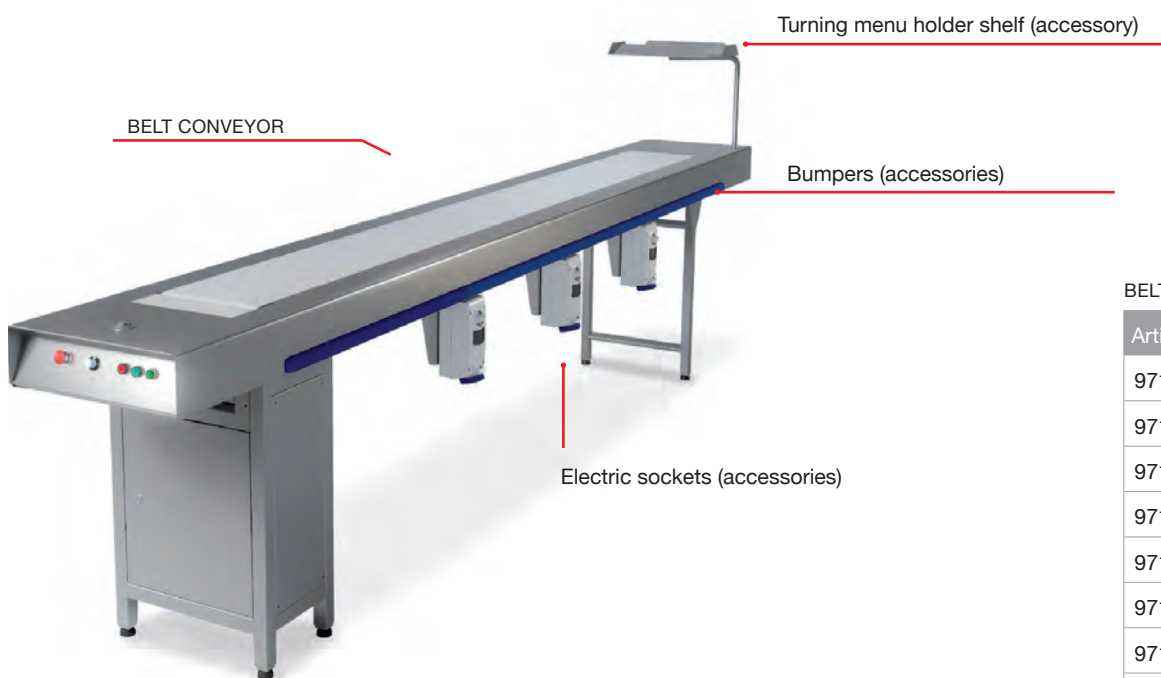

BELT CONVEYOR

Articles	length (m)
9710-3	3
9710-4	4
9710-5	5
9710-6	6
9710-7	7
9710-8	8
9710-9	9
9710-10	10

Prices upon request



CORD CONVEYOR

Articles	length (m)
9711-3	3
9711-4	4
9711-5	5
9711-6	6
9711-7	7
9711-8	8
9711-9	9

Prices upon request



Accessories	Description
9710-ACC 1	Control panel from 1 to 8 sockets
9710-ACC 2	Control panel from 9 to 16 sockets
9710-ACC 3	Single electrical socket 230V CEE
9710-ACC 4	Double opposed electrical sockets 230V CEE
9710-ACC 5	Single electrical socket 230V Schuko
9710-ACC 6	Double opposed electrical sockets 230V Schuko
9710-ACC 7	Bumpers (fitted on the long sides)
9710-ACC 8	Folding side shelf 50x30 cm
9710-ACC 9	Turning menu holder shelf 50x30 cm
9710-ACC 10	Additional start/stop button
9710-ACC 11	Start/stop pedal at the end of the conveyor belt
9710-ACC 12	End stop photocell
9710-ACC 13	On castors ø 12.5 cm

Prices upon request

GLASS DISPENSERS AND LOWERATORS

- AISI 304 stainless steel sheet construction, brushed finish
- Available with 6 or 20 lowerators, with adjustable Ø 7.6 ÷ 9.8 cm
- Pushing handle
- Grey rubber ring buffers
- Non-marking swivel castors Ø 12.5 cm, 2 with brake



Art. 9800-6



Art. 9800-20

Article	€	Number of lowerators	glass/cup Ø	Max dim. cm
9800-6	3.475,00	6	76 ÷ 98 mm	85x41x86 h
9800-20	9.250,00	20	76 ÷ 98 mm	87x66x86 h

- AISI 304 stainless steel sheet construction, brushed finish
- Pushing handle
- Suitable for GN 1/1 – EN trays (platform available in other formats upon request)
- 1 open elevating column
- Lifting system adjustable according to the weight
- Rubber corner bumpers
- Castors ø 12.5 cm, 2 with brake



Pushing handle

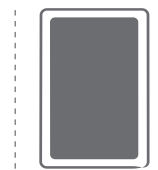
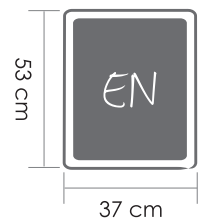
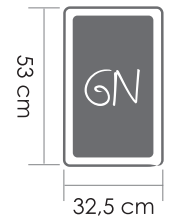

FORMATS
ON REQUEST



Art. 9705GN

Article	€	Trays	Max dim. cm
9705GN	1.075,00	1/1 GN	81x52x90 h
9705EN	1.075,00	EN	

PLATE DISPENSERS AND LOWERATORS

NEUTRAL VERSION

- AISI 304 stainless steel sheet construction, brushed finish
- Heat-proof pushing handle
- 1 or 2 columns suitable for plates of various diameters (depending on the model), with load adjustment by springs
- Lids included
- Rubber corner bumpers
- Swivel castors \varnothing 12.5 cm, 2 with brake

HEATED VERSION

As in the neutral version, in addition:

- ON/OFF switch with warning light
- Adjustable thermostat
- Ventilated heating
- Mains supply: 230V, 50 Hz (60 Hz upon request), single-phase
- 3-mt long coiled power cable

REFRIGERABLE VERSION

As in the neutral version, with:

- AISI 304 stainless steel sheet construction, brushed finish, perforated

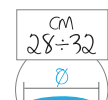
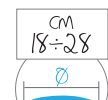
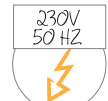
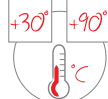

Art. 9701-1828RN

☐ = neutral ☀ = hot ❄ = refrigerable

Article	€		Description	Plate \varnothing cm	Plate capacity	Power	Max dim. cm
9701-1621FN	806,00	☐	1 Fixed plate lowerator	16÷21	-	-	60x50x89 h
9701-1621FC	1.200,00	☀				900W	
9701-1621FR	881,00	❄					
9701-1828RN	888,00	☐	1 Adjustable plate lowerator	18÷28	about 50-60	-	
9701-1828RC	1.392,00	☀				900W	
9701-1828RR	963,00	❄					
9701-2832RN	985,00	☐		28÷32	-	-	
9701-2832RC	1.520,00	☀				900W	
9701-2832RR	1.060,00	❄					

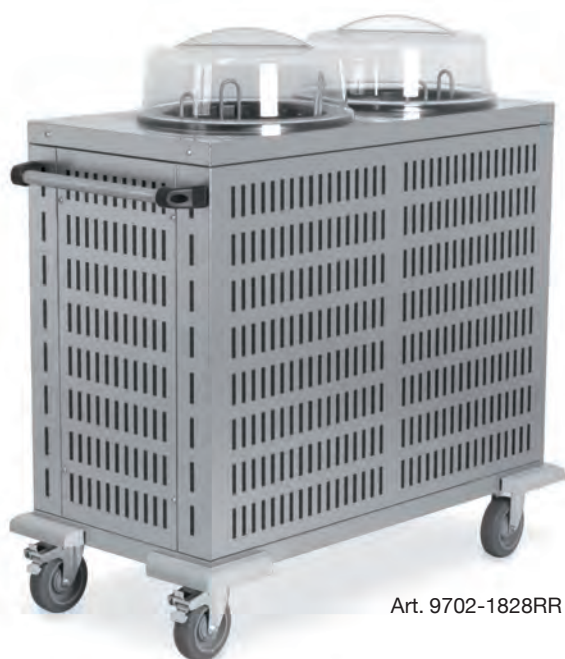

Art. 9702-1828RR



Art. 9702-1828RC

☰ = neutral ☀ = hot ☄ = refrigerable

Article	€		Description	Plate Ø cm	Plate capacity	Power	Max dim. cm
9702-1621FN	1.223,00	☰	2 Fixed plate lowerators	16÷21	about 100-120	-	95x50x89 h
9702-1621FC	1.764,00	☀				900W	
9702-1621FR	1.298,00	☄					
9702-1828RN	1.350,00	☰	2 Adjustable plate lowerators	18÷28	about 100-120	-	
9702-1828RC	1.985,00	☀				900W	
9702-1828RR	1.425,00	☄					
9702-2832RN	1.494,00	☰		28÷32		-	
9702-2832RC	2.115,00	☀				900W	
9702-2832RR	1.569,00	☄					
Accessories	€		Description	Suitable for			
9703-1621	94,00		1 Lid	9701-1621FN / 9701-1621FC / 9701-1621FR 9702-1621FN / 9702-1621FC / 9702-1621FR			
9703-1828	100,00			9701-1828RN / 9701-1828RC / 9701-1828RR 9702-1828RN / 9702-1828RC / 9702-1828RR			
9703-2832	115,00			9701-2832RN / 9701-2832RC / 9701-2832RR 9702-2832RN / 9702-2832RC / 9702-2832RR			

NEUTRAL/HEATED/REFRIGERABLE RACK LOWERATOR TROLLEYS

NEUTRAL VERSION

- AISI 304 stainless steel sheet construction, brushed finish
- Pushing handle
- One column suitable for 50x50 cm racks, load adjustment by springs
- Sliding rack, rilsan finish
- Polycarbonate lid with side support for hooking when in rest position
- Grey non marking rubber corner bumpers
- 4 swivel castors ø 12.5 cm, 2 with brake

HEATED VERSION

As in the neutral version, in addition:

- ON/OFF switch with warning light
- Adjustable thermostat
- Ventilated heating
- Mains supply: 230V, 50 Hz (60 Hz upon request), single-phase
- 3-mt long coiled power cable

REFRIGERABLE VERSION

As in the neutral version, with:

- AISI 304 stainless steel sheet construction, brushed finish, perforated

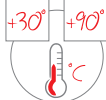

Art. 9704N



Art. 9704R



Art. 9704C

☰ = neutral ☀ = hot ☰ = refrigerable

Article	€		Loading capacity	Power	Max dim. cm
9704N	1.550,00	☰		-	76x79.4x93 h (with lid h 108)
9704R	1.760,00	☰	5 racks cm 50x50x11.5 h 9 racks cm 50x50x 7.5 h	-	76x79.4x93 h (with lid h 108)
9704C	2.090,00	☀		900W	76x89.4x93 h (with lid h 108)

REFRIGERATED RACK LOWERATOR TROLLEY

- AISI 304 stainless steel insulated structure, brushed finish
- Pushing handle
- One column suitable for 50x50 cm racks, load adjustment by springs
- Sliding rack, rilsan finish
- Polycarbonate lid with side support for hooking when in rest position
- Ventilated refrigeration +2°C +10°C
- Automatic defrosting and condensation evaporation
- Control panel with ON/OFF switch with warning light and digital thermostat, coiled power cable
- Power supply 230V – 50 Hz (60 Hz upon request), single-phase
- Grey non marking rubber corner bumpers
- 4 swivel castors ø 12.5 cm, 2 with brake

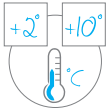

Art. 9704F

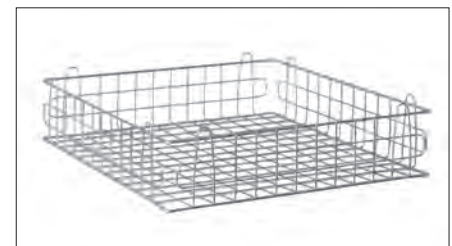

Stainless steel rack (Art. 9704-115CEST)

 = refrigerated

Article	€		Loading capacity	Power	Max dim. cm
9704F	4.990,00		5 racks cm 50x50x11.5 h 9 racks cm 50x50x7.5 h	167 W	121x75x94 h (with lid h 108)
Accessories	€		Description	Suitable for	Dimensions (cm)
9704-115CEST	180,00		Stainless steel rack	9704N / 9704R 9704C / 9704F	50x50x11.5 h
9704-75CEST	170,00		Stainless steel rack	9704N / 9704R 9704C / 9704F	50x50x7.5 h

BAIN-MARIE TROLLEYS

- 2,5x2,5 cm square steel tube construction with AISI 304 stainless steel sheet panels, brushed finish
- Polyurethane foam insulation panels
- Heat-proof pushing handle
- Lower welded shelf
- Bain-Marie well made of pressed steel sheet with no sharp edges for up to 20 cm deep GN pans (not included)
- Bain-Marie drain tap
- Bain-marie heating with heating element outside the well
- Dry heating: details and quotes upon request
- ON/OFF switch with warning light
- Control panel with adjustable thermostat
- Mains supply 230V, 50/60Hz, single-phase
- Rubber corner bumpers
- Swivel castors, ø cm 12.5

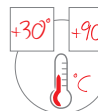

Optional Gatronorms: see pp. 132-133



Art. 7365-F



Art. 7375-F

Article	€	GN	Power	Max. Dim. cm
7360	1.448,00	2/1	1200W	87x65x86 h
7365	1.737,00	3/1	1500W	125x65x86 h
7368	2.066,00	4/1	2400W	163x65x86 h
7370	1.478,00	2x1/1	1200W	87x65x86 h
7375	2.120,00	3x1/1	1800W	125x65x86 h
7378	2.532,00	4x1/1	2400W	163x65x86 h
Optional	€	Image	Description	Suitable
F	22,00	1	Set with 2 braked castors	All articles



STAINLESS STEEL REFRIGERATED TROLLEYS

- 2.5x2.5 cm square tube construction and panels in AISI 304 stainless steel sheet, brushed finish
- Side pushing handle
- Lower shelf
- AISI 304 stainless steel 19 cm-deep well for up to 15 cm-deep GN pans (not included)
- Condensate drain at the base of the well with drain tap
- Control panel with digital thermostat-thermometer and ON/OFF switch with warning light
- Mains supply: 230V, 50Hz (60Hz upon request), single-phase
- Static refrigeration +4°C +10°C
- Grey non marking rubber bumper
- Swivel castors ø 12.5 cm, 2 with brake

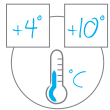

Optional Gastronorms: see pp. 132-133



Art. 6962.3

Article	€	GN	Power	Max dim. cm
6962.2	2.548,00	2x1/1	190W	87x75x88 h
6962.3	2.956,00	3x1/1	350W	120x75x88 h
6962.4	3.482,00	4x1/1	450W	168x75x88 h

Optional	€	📷	Description	GN
CUP2	612,00	-	Plexiglass semi-cylindrical dome opening on both sides	2x1/1
CUP3	668,00	1		3x1/1
CUP4	723,00	-		4x1/1
A132	111,00	-	Front drop-down shelf	2x1/1
A133	125,00	2		3x1/1
A134	166,00	-		4x1/1
A142	117,00	-	Front drop-down stainless steel rodded tray slide	2x1/1
A143	130,00	3		3x1/1
A144	166,00	-		4x1/1
Accessories	€	📷	Description	GN
A10	31,00	4	Flat	1/1
A20	36,00	5	Perforated	

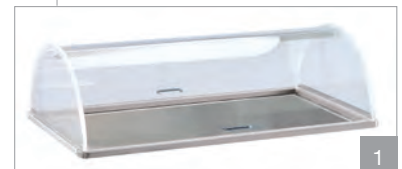

HEATED INSULATED PAN MOBILE CUPBOARDS

- AISI 304 stainless steel insulated structure, brushed finish
- 270° opening front door with magnet (to keep the door open)
- Removable door gasket
- Handle with snap closure, optional with lock
- Pushing handle
- Inside compartment made with round corners in compliance with H1 hygiene standard, suitable for GN pans
- Ventilated heating unit powered with fan and heating element
- Control panel with ON/OFF switch with operation warning light and digital thermostat, coiled power cord on the backside
- Mains supply: 230V - 50 Hz (60 Hz upon request), single-phased
- Water container to release moisture inside the cupboard
- All round grey non marking rubber bumper
- Swivel castors, ø cm 12.5, 2 with brake

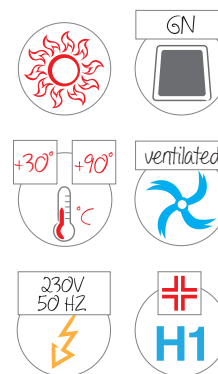

Art. 3411-20GS



Art. 3421-10GS



Pressed runners
made with one single sheet layer for easy cleaning



Compartment with no-sharp edges
compliant with "H1" hygiene system



270° opening door
To easily fit GN pans

Article	€	GN	Runners	Shelf spacing cm	Power	Max dim. cm
3411-10GS	2.977,00	10 GN 1/1		5.5	1600W	55x80x110 h
3421-10GS	3.281,00	10 GN 2/1				72x92x110 h
3411-20GS	3.570,00	20 GN 1/1				55x80x166 h
3421-20GS	3.937,00	20 GN 2/1				72x92x166 h
Optional	€	Description				Suitable for
E	80,00	4 resilient castors, ø cm 12.5, 2 with brake, for uneven floors/outdoor use				All articles
MA	107,00	Closure handle with lock				
Accessories	€	Description				Suitable for
A0170	39,00	Stainless steel wire rack 1/1 GN				3411-10GS / 3411-20GS
A0171	64,00	Stainless steel wire rack 2/1 GN				3421-10GS / 3421-20GS

REFRIGERATED INSULATED PAN MOBILE CUPBOARD

- AISI 304 stainless steel insulated structure, brushed finish
- 270° opening front door with magnet (to keep the door open)
- Handle with snap closure, optional with lock
- Pushing handles
- Inside compartment equipped with 16 pressed runners suitable for 1/1 GN containers made with round corners in compliance with H1 hygiene standard
- Ventilated refrigeration +2°C +10°C
- Automatic defrosting and evaporation
- Control panel with ON/OFF switch with operation warning light and digital thermostat, coiled power cord on the backside
- Mains supply: 230V - 50Hz, 60Hz upon request
- All round grey non marking rubber bumper
- Swivel castors, ø cm 12.5, 2 with brake

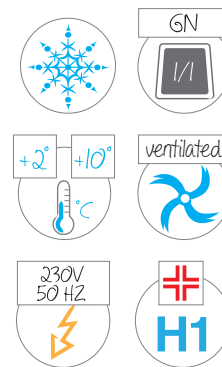

Art. 3415-16GS



Pressed runners
made with one single sheet layer for easy cleaning



Compartment with no-sharp edges
compliant with "H1" hygiene system



270° opening door
To easily fit GN pans

Article	€	Tray/pan capacity	Runners	Shelf spacing cm	Power	Max diim. cm
3415-16GS	4.990,00	16 x 1/1 GN		5.5	330W	55.5x79.5x165 h
Optional	€	Description				
E	80,00	4 resilient castors, ø cm 12.5, 2 with brake, for uneven floors/outdoor use				
MA	107,00	Closure handle with lock				
Accessories	€	Description				
A0170	39,00	Stainless steel wire rack 1/1 GN				





Countertop hotplates
Infrared lamps
Bain-Marie trolleys
Containers, dividers and lids



COUNTERTOP HOTPLATES _____ 96



HEATED DISPLAY CASE _____ 97



INFRARED LAMPS _____ 100



COUNTERTOP BAIN-MARIE UNITS _____ 102



BAIN-MARIE TROLLEYS _____ 104



BAIN-MARIE CUPBOARD TROLLEYS WITH PRESSED RUNNERS _____ 114



BAIN-MARIE CUPBOARD TROLLEYS WITH "C"- SHAPED RUNNERS _____ 120



ACCESSORIES AND OPTIONAL PARTS FOR BAIN-MARIE _____ 130



GN CONTAINERS, LIDS AND DIVIDERS _____ 132

COUNTERTOP HOTPLATES

- AISI 304 stainless steel sheet top
- Heated by electrical heating element
- ON/OFF switch with warning light
- Adjustable thermostat
- Mains supply: 230V, 50/60 Hz, single-phase
- Rubber feet

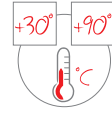

Art. 9082

Article	€	GN	Power	Max dim. cm
9080	183,00	1x1/1	250W	33x53x6 h
9082	230,00	2x1/1	500W	66x53x6 h
9084	278,00	3x1/1	750W	99x53x6 h
9086	321,00	4x1/1	1000W	132x53x6 h
905050	227,00	-	300W	50x50x6 h
906040	219,00		300W	60x40x6 h
906080	287,00		450W	80x60x6 h

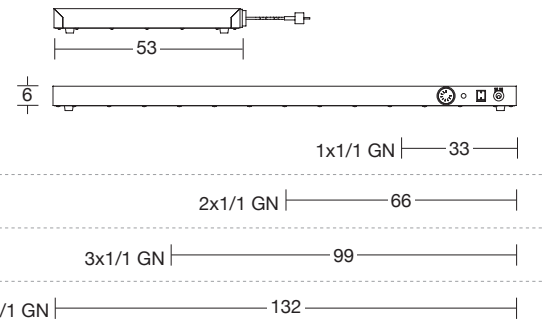

Article	€	Power	Max dim. cm
9035	214,00	250W	50x35x6 h
9040	281,00	300W	63x53x6 h
9045	289,00	450W	90x45x6 h
9050	321,00	750W	100x50x6 h
9051	309,00	750W	92x52x6 h
9053	264,00	450W	86x46x6 h

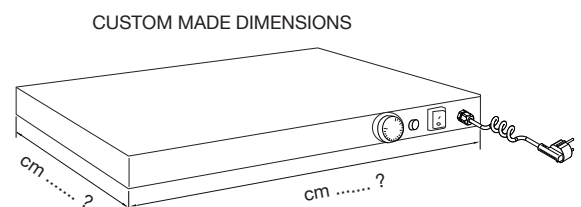

HEATED DISPLAY CASE

- AISI 304 stainless steel sheet top
- Plexiglass semi-cylindrical dome, opening on both sides
- Heated by electrical heating element
- ON/OFF switch with warning light
- Thermostatic control
- Mains supply: 230V, 50/60 Hz, single-phase
- Rubber feet

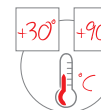

Art. 9070

Article	€		Power	Max dim. cm
9070	567,00		450W	92x52x32 h



COUNTERTOP HOTPLATES WITH INFRARED LAMPS

- AISI 304 stainless steel sheet top
- Built-in upper frame in tube and stainless steel sheet
- Plexiglass curved sneeze guard
- Infrared lamps, 250W each, red colour
- Heated by electrical heating element
- Separate switches for hotplate and infrared lamps, with warning light
- Adjustable thermostat
- Mains supply: 230V, 50/60 Hz, single-phase
- Rubber feet

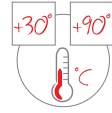

Art. 9568

Article	€	GN	Nr. of lamps	Power	Max dim. cm
9564	422,00	1x1/1	1	500W	38x53x70 h
9566	572,00	2x1/1	2	1000W	70x53x70 h
9568	740,00	3x1/1	3	1500W	103x53x70 h
9570	894,00	4x1/1	4	2000W	136x53x70 h

Optional	€	Description	Suitable for
LB	18,00	White lamps	All articles

- Plexiglass curved sneeze guard
- Infrared lamps, 250W each, red colour
- ON/OFF switch with warning light
- Mains supply: 230V, 50/60 Hz, single-phase
- Rubber feet



- STAINLESS STEEL SHEET HANGING SUPPORT

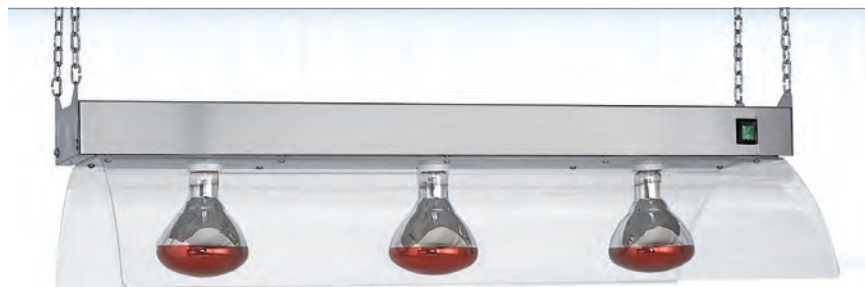

Art. 9568S

- STAINLESS STEEL SHEET FRAME



Art. 9568T

Article	€	GN	Nr. of lamps	Power	Max dim. cm
9566S	375,00	2x1/1	2	500W	71x53x24 h
9568S	500,00	3x1/1	3	750W	104x53x24 h
9570S	615,00	4x1/1	4	1000W	137x53x24 h
9564T	328,00	1x1/1	1	250W	38x53x70 h
9566T	432,00	2x1/1	2	500W	70x53x70 h
9568T	556,00	3x1/1	3	750W	103x53x70 h
9570T	671,00	4x1/1	4	1000W	136x53x70 h
Optional	€	Description		Suitable for	
LB	18,00	White lamps		Tutti	

INFRARED LAMPS

- Height-adjustable lamp holder
- Infrared lamp, 250 W, red colour or white colour upon request
- ON/OFF switch on lamp holder body
- Mains supply: 230V, 50/60 Hz, single-phase



Art. 9510A



Art. 9511A



Art. 9512A

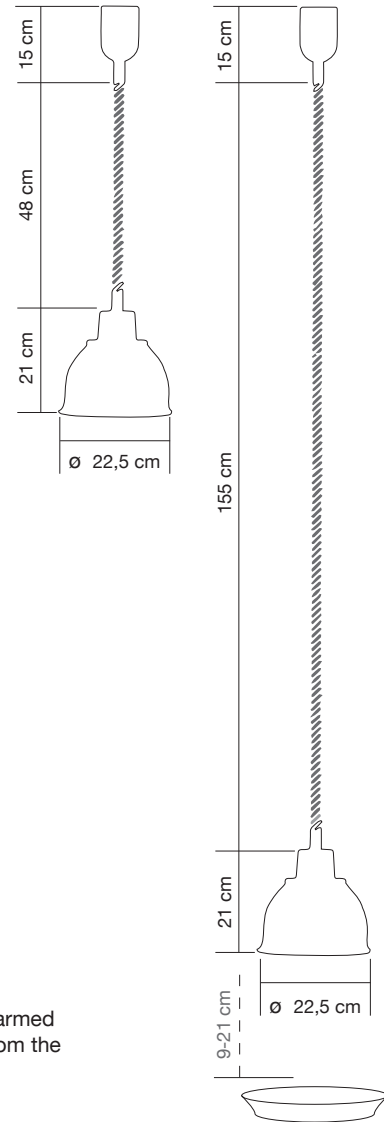

Better to keep the food to be warmed at a distance from 9 to 21 cm from the lamp holder

Article	€	Finish	Cable length	Power	Max dim. cm
9510A	265,00	Aluminium	Adjustable 48 - 155 cm	250W	ø 22,5
9511A	387,00	Chrome-plated			
9512A	387,00	Copper			

Optional	€	Description	Suitable for
LB-1	18,00	White lamp	All articles

INFRARED LAMPS

- Height-adjustable lamp holder
- Infrared lamp, 250 W, red colour or white colour upon request
- ON/OFF switch on lamp holder body
- Mains supply: 230V, 50/60 Hz, single-phase



Art. 9516A

Art. 9518A

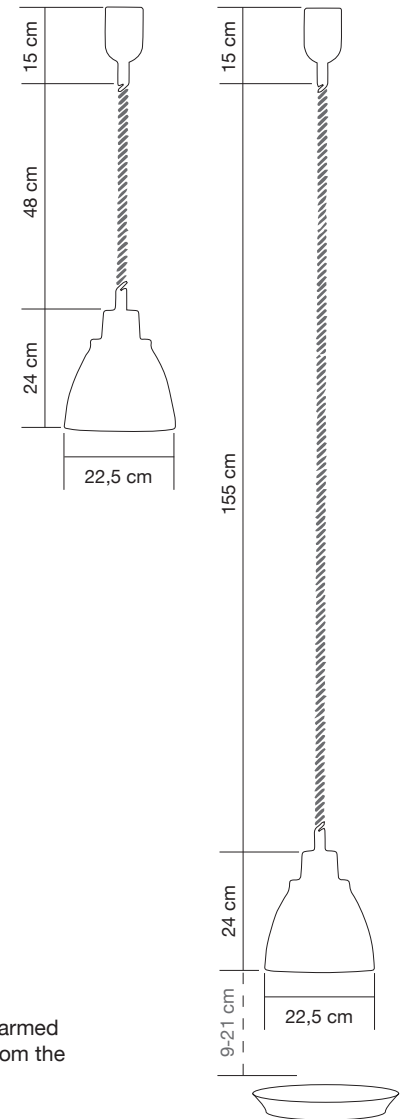

Better to keep the food to be warmed at a distance from 9 to 21 cm from the lamp holder

Article	€	Finish	Cable length	Power	Max dim. cm
9516A	467,00	Brass-plated	Adjustable, 48 - 155 cm	250W	ø 22.5
9518A	292,00	Black			

Optional	€	Description	Suitable for
LB-1	18,00	White lamp	All articles

COUNTERTOP BAIN-MARIE UNITS

- AISI 304 Stainless steel structure
- Double skinned steel sheet well for up to 15 cm-deep GN 1/1 pans (not included) with separate temperature control
- Bain-marie heating with heating element outside the well
- Dry heating: details and quotes upon request
- For each well:
 - Bain-Marie drain tap
 - Adjustable thermostat
 - ON/OFF switch with warning light
- Mains supply: 230V, 50/60 Hz, single-phase

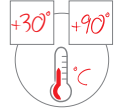

Optional Gastronorms: see pp. 132-133



Art. 9555-2

WITH DRY HEATING ELEMENTS

- AISI 304 Stainless steel structure
- Double skinned well for up to 15 cm-deep GN pans (not included)
- Grill on the bottom
- Dry heating element
- ON/OFF switch with warning light
- Adjustable thermostat
- Mains supply: 230V, 50/60 Hz, single-phase
- Adjustable feet
- Dry heating only



Art. 9531RS

Article	€	GN	Well	Power	Max dim. cm
9555-1	348,00	1x1/1	Separate	600W	34x60x24 h
9555-2	551,00	2x1/1		1200W	70x60x24 h
9555-3	742,00	3x1/1		1800W	106x60x24 h
9551RS	661,00	2/1	Single	1000W	82x61x34 h
9531RS	766,00	3/1		2x1000W	115x61x34 h
9521RS	871,00	4/1			153x61x34 h

COUNTERTOP BAIN-MARIE UNITS

- Double skinned AISI 304 stainless steel sheet construction
- Bain-Marie well for up to 20 cm-deep GN pans (not included)
- Bain-Marie drain tap
- Bain-Marie immersion heating element
- ON/OFF switch with warning light
- Adjustable thermostat
- Mains supply: 230V, 50/60 Hz, single-phase
- Adjustable feet
- Bain-Marie only

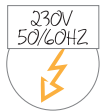
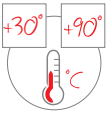

Optional Gastronorms: see pp. 132-133



Art. 9531 + pans



Art. 9531-GR3

Article	€	GN	Power	Max dim. cm
9541	626,00	1/1	1950W	49x60x34 h
9551	731,00	2/1		81x60x34 h
9531	834,00	3/1		114x60x34 h
9521	955,00	4/1	3400W	153x60x34 h

Accessories	€	Bottom safety grill	Suitable for
GR1	49,00	1x1/1 GN	9541
GR2	57,00	2x1/1 GN	9551
GR3	66,00	3x1/1 GN	9531
GR4	74,00	4x1/1 GN	9521

BAIN-MARIE TROLLEYS WITH LID

- 2x2 cm square steel tube construction with AISI 304 stainless steel sheet panels, brushed finish
- Hinged top lid
- Bain-Marie well for up to 20 cm-deep GN pans (not included)
- Grill on the bottom
- Bain-Marie immersion heating element and drain tap
- Bain-Marie drain tap
- ON/OFF switch with warning light
- Adjustable thermostat
- Mains supply: 230V, 50/60 Hz, single-phase
- Open lower part
- Swivel castors, ø 12.5 cm
- Bain-Marie only

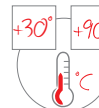

Optional Gastronorms: see pp. 132-133



Art. 1393

Article	€	GN	Power	Max dim. cm
1391	813,00	1/1	1950W	49x60x90 h
1392	912,00	2/1		81x60x90 h
1393	1.045,00	3/1		114x60x90 h

Optional	€		Description	Suitable for
F	22,00	1	Set with 2 braked castors	All articles 
A0040	26,00	-	Pushing handle	

Accessories	€	Description	Suitable for
A0431	46,00	Lower s/s additional shelf	1391
A0432	69,00		1392
A0433	92,00		1393

BAIN-MARIE TROLLEYS

- 2x2 cm square steel tube construction with AISI 304 stainless steel sheet panels, brushed finish
- Bain-Marie well for up to 20 cm-deep GN pans (not included)
- Bain-Marie immersion heating element and drain tap
- Bain-Marie drain tap
- ON/OFF switch with warning light
- Adjustable thermostat
- Mains supply: 230V, 50/60 Hz, single-phase
- Open lower part with removable shelf
- Swivel castors, ø 12.5 cm
- Bain-Marie only

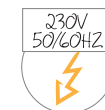
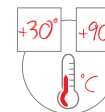

Optional Gastronorms: see pp. 132-133



Art. 1397

Article	€	GN	Power	Max dim. cm
1395	790,00	1/1	1950W	49x60x84 h
1396	906,00	2/1		81x60x84 h
1397	1.004,00	3/1		114x60x84 h
1398	1.181,00	4/1	3400W	153x60x84 h

Optional	€	📷	Description	Suitable for
F	22,00	1	Set with 2 braked castors	All articles
A0040	26,00	-	Pushing handle	



Accessories	€	Bottom safety grill	Suitable for
GR1	49,00	1x1/1 GN	1395
GR2	57,00	2x1/1 GN	1396
GR3	66,00	3x1/1 GN	1397
GR4	74,00	4x1/1 GN	1398

HEATED TROLLEYS WITH SEPARATE TEMPERATURE CONTROL

- AISI 304 stainless steel structure
- Double skinned well for up to 15 cm-deep GN pans (not included) with separate temperature control
- Bain-marie heating with heating element outside the well
- Dry heating: details and quotes upon request
- For each well:
 - Bain-Marie drain tap
 - Adjustable thermostat
 - ON/OFF switch with warning light
- Mains supply: 230V, 50/60 Hz, single-phase
- Pushing handle
- Swivel castors ø 12.5 cm, 2 with brake

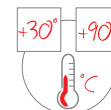

Optional Gastronorms: see pp. 132-133



Art. 7370RS

Article	€	GN	Well	Power	Max dim. cm
7370RS	973,00	2x1/1	Separate	2x600W	88x61x85 h
7375RS	1.243,00	3x1/1		3x600W	121x61x85 h

HEATED TROLLEYS WITH DRY HEATING ELEMENTS

- AISI 304 Stainless steel structure
- Double skinned well for up to 15 cm-deep GN pans (not included)
- Grill on the bottom
- Dry heating element
- ON/OFF switch with warning light
- Adjustable thermostat
- Mains supply: 230V, 50/60 Hz, single-phase
- Pushing handle
- Swivel castors ø 12.5 cm, 2 with brake
- Dry heating only

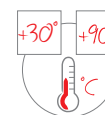

Optional Gastronorms: see pp. 132-133



Art. 1397RS

Article	€	GN	Well	Power	Max dim. cm
1396RS	798,00	2/1	Single	1000W	88x61x85 h
1397RS	903,00	3/1		2x1000W	121x61x85 h
1398RS	1.008,00	4/1			159x61x85 h

BAIN-MARIE TROLLEYS - SINGLE WELL

- 2.5x2.5 cm square steel tube construction with AISI 304 stainless steel sheet panels, brushed finish
- Polyurethane foam insulation panels
- Heat-proof pushing handle
- Lower welded shelf
- Single Bain-Marie well made of pressed steel sheet with no sharp edges for up to 20 cm deep GN pans (not included)
- Bain-Marie drain tap
- Bain-marie heating with heating element outside the well
- Dry heating: details and quotes upon request
- ON/OFF switch with warning light
- Control panel with adjustable thermostat
- Mains supply: 230V, 50/60 Hz, single-phase
- Rubber corner bumpers
- Swivel castors, ø 12.5 cm

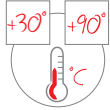

Optional Gastronorms: see pp.132-133





Art. 7365-F

Article	€	GN	Power	Max dim. cm
7360	1.448,00	2/1	1200W	87x65x86 h
7365	1.737,00	3/1	1500W	125x65x86 h
7368	2.066,00	4/1	2400W	163x65x86 h

Optional	€	Image	Description	Suitable for
F	22,00		Set with 2 braked castors	All articles

LID

- Insulated lids, when open they can be used as support
- AISI 304 stainless steel sheet construction, brushed finish

Optional	€	Descrizione	Typology	Suitable for		
C2	634,00	Lids	opening to 180°	2x1/1 GN		
C3	670,00			3x1/1 GN		

SNEEZE GUARD

Optional	€		Description	Typology	Suitable for
PAR2L	484,00	2	Glass sneeze guard	Standard	2x1/1 GN
PAR2H	543,00	3		"Kid-service" opening	
PAR3L	508,00	2		Standard	3x1/1 GN
PAR3H	572,00	3		"Kid-service" opening	
PAR4L	573,00	2		Standard	4x1/1 GN
PAR4H	586,00	3		"Kid-service" opening	

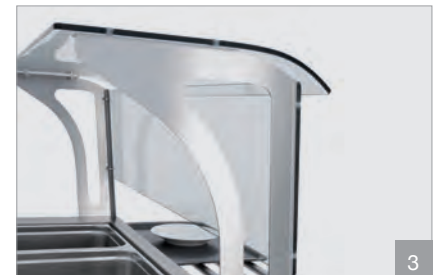

TRAY SLIDE SHELF

Optional	€	Description	Suitable for
ME2	145,00	Tray slide shelf, long side	2x1/1 GN
ME3	159,00		3x1/1 GN
ME4	205,00		4x1/1 GN



BAIN-MARIE TROLLEYS WITH SEPARATE WELLS

- 2.5x2.5 cm square steel tube construction with AISI 304 stainless steel sheet panels, brushed finish
- Polyurethane foam insulation panels
- Heat-proof pushing handle
- Lower welded shelf
- Bain-Marie wells with separate temperature control in pressed steel sheet with no sharp edges for up to 20 cm-deep GN pans (not included)

- Bain-marie heating with heating element outside the well
- Dry heating: details and quotes upon request
- ON/OFF switch with warning light
- Control panel with adjustable thermostat
- Mains supply: 230V, 50/60 Hz, single-phase
- Rubber corner bumpers
- Swivel castors, ø 12.5 cm

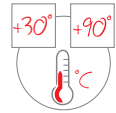

Optional Gastronorms: see pp.132-133





Art. 7375-F

Article	€	GN	Power	Max dim. cm
7370	1.478,00	2x1/1	1200W	87x65x86 h
7375	2.120,00	3x1/1	1800W	125x65x86 h
7378	2.532,00	4x1/1	2400W	163x65x86 h

Optional	€	Image	Description	Suitable for
F	22,00		Set with 2 braked castors	All articles 

LID

- Insulated lids, when open they can be used as support
- AISI 304 stainless steel sheet construction, brushed finish

Optional	€	Descrizione	Typology	Suitable for		
C2	634,00	Lids	opening to 180°	2x1/1 GN		
C3	670,00			3x1/1 GN		

SNEEZE GUARD

Optional	€		Description	Typology	Suitable for
PAR2L	484,00	2	Glass sneeze guard	Standard	2x1/1 GN
PAR2H	543,00	3		"Kid-service" opening	
PAR3L	508,00	2		Standard	3x1/1 GN
PAR3H	572,00	3		"Kid-service" opening	
PAR4L	573,00	2		Standard	4x1/1 GN
PAR4H	586,00	3		"Kid-service" opening	



TRAY SLIDE SHELF

Optional	€	Description	Suitable for
ME2	145,00	Tray slide shelf, long side	2x1/1 GN
ME3	159,00		3x1/1 GN
ME4	205,00		4x1/1 GN



CUPBOARD BAIN-MARIE TROLLEYS OVERVIEW

Technical features

- AISI 304 stainless steel, brushed finish
- Polyurethane foam insulation panels
- Heat-proof pushing handles
- Single or separate Bain-Marie wells, suitable for GN pans
- One or more Bain-Marie drain taps
- Single or separate neutral, heated, refrigerated or mixed lower compartments
- Mains supply: 230V, 50/60 Hz, single-phase
- Bain-marie heating with heating element outside the well
- Dry heating: details and quotes upon request
- Control panel with independent thermostatic control, one for each heated (+30°C to +90°C) or refrigerated (+4°C to +10°C) compartment.
- 3-mt long coiled power cable, SCHUKO plug
- All round grey non marking rubber bumpers
- Castors Ø 16 cm, 2 fixed, 2 swivel with brake

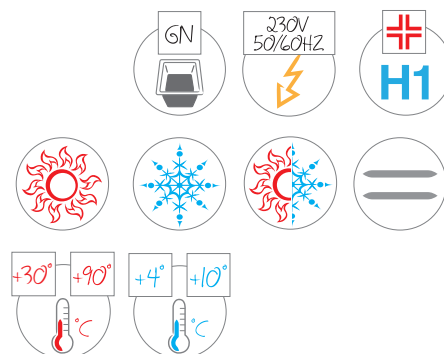

Optional

LIDS FOR 2 GN - 3 GN ITEMS



(C2-C3)
Lids opening to 180°



(L2-L3)
Lids opening 2/3 + 1/3 on the long side



(S2-S3)
Sliding lids on the long side



STEEL AND GLASS
SNEEZE GUARD
(it cannot be mounted
on trolleys with lids)

Art. PAR2L - PAR3L - PAR4L



STEEL AND GLASS SNEEZE
GUARD WITH
"KID-SERVICE" OPENING
(it cannot be mounted
on trolleys with lids)

Art. PAR2H - PAR3H - PAR4H



TRAY SLIDE SHELF
frontal, drop-down



IPX5 INSULATED
DIGITAL PANEL



TOW BAR
WITH COUPLER



SET OF 4 RESILIENT WHEELS,
2 with brake for
uneven floors / outdoor use

Separate lower compartments with "C"-shaped runners

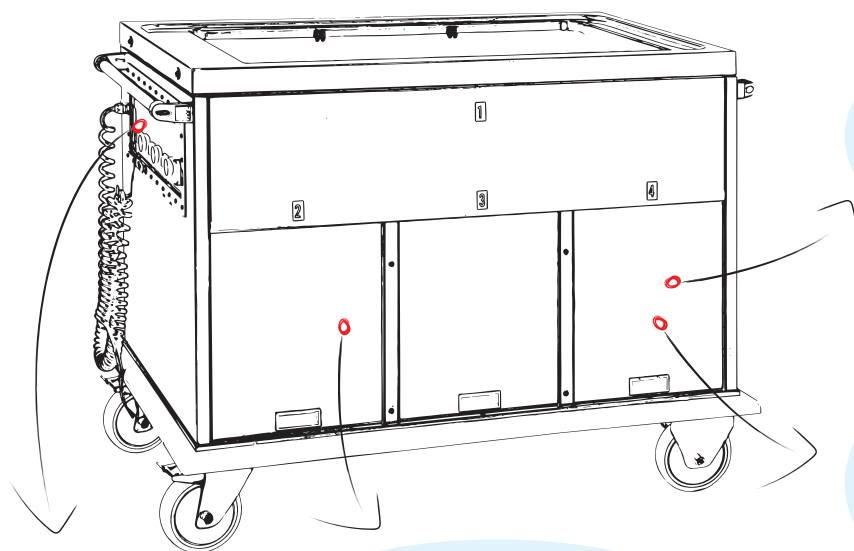
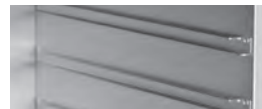

- Up-and-over opening doors

- Single or separate lower compartments



- Mechanical thermostats



- "C"-shaped runners to easily fit pans and for a greater support

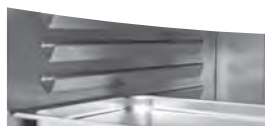

Separate lower compartments compliant with "H1" system with pressed runners

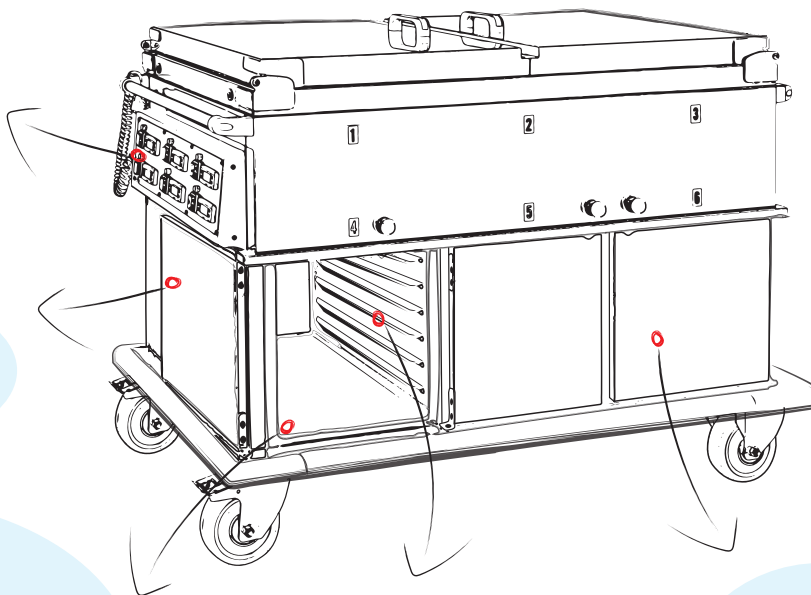

- Digital thermostats

- 270° opening doors with magnet



- Compartment with no-sharp edges compliant with "H1" hygiene system

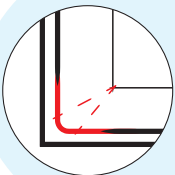

- Pressed runners made with one single steel sheet layer for easy cleaning

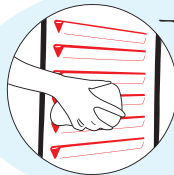

- Separate lower compartments



BAIN-MARIE CUPBOARD TROLLEYS - SINGLE WELL LOWER COMPARTMENTS WITH PRESSED SHELVES

- AISI 304 stainless steel sheet construction, brushed finish
- Polyurethane foam insulation panels
- Heat-proof pushing handles
- Single Bain-Marie well in pressed steel sheet with no sharp edges for up to 20 cm-deep GN pans (not included)
- Bain-Marie drain tap
- Separate heated or neutral lower compartments with no-sharp edges (compliant with H1 hygiene system), with independent thermostats, insulated 270° opening side doors, with magnet (to keep the doors open). N. 6 pairs of "pressed" runners suitable for containers 1/1 GN (or submultiples) spaced 5.5 cm

- Mains supply: 230V, 50/60 Hz, single-phase
- Bain-marie heating with heating element outside the well
- Dry heating: details and quotes upon request
- IPX5 digital control panel supplied as standard with independent thermostatic control - one thermostat for each heated well/compartment
- 3-mt long coiled power cable, SCHUKO plug
- All round grey non marking rubber bumpers
- 2 Fixed and 2 braked swivel castors with heavy-duty brackets, ø 16 cm; grey non marking rubber tread on centre with roller bearing hub



Optional + accessories: see pp. 130-131

Optional Gastronorms: see pp. 132-133



Note: IPX5 digital control panel is supplied as standard in the Bain-Marie trolleys with pressed runners ("GS" range)



Art. 7365A3-GS-E

☐ = neutral ☀ = hot





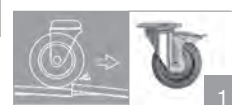

Article	€	GN	Lower compartment	Power	Max dim. cm
7360A0-GS	3.171,00	2/1	☐ ☐	1200W	95x72x96 h
7360A1-GS	3.297,00		☐ ☀	1600W	
7360A2-GS	3.423,00		☀ ☀	2000W	
7365A0-GS	3.953,00	3/1	☐ ☐ ☐	1500W	134x72x96 h
7365A1-GS	4.143,00		☐ ☐ ☀	1900W	
7365A2-GS	4.263,00		☐ ☀ ☀	2300W	
7365A3-GS	4.384,00		☀ ☀ ☀	2700W	

Optional	€	📷	Description	Suitable for
E	60,00	1	Set of 4 resilient wheels, 2 with brake for uneven floors / outdoor use	All articles



LID

- Insulated lids, when open they can be used as support
- AISI 304 stainless steel sheet construction, brushed finish

Optional	€	Description	Typology	Suitable for		
C2	634,00	Lids	opening to 180°	2x1/1 GN		
C3	670,00			3x1/1 GN		
L2	662,00		opening to 2/3 + 1/3	2x1/1 GN		
L3	737,00			3x1/1 GN		
S2	1.772,00		sliding	2x1/1 GN		
S3	1.963,00			3x1/1 GN		

SNEEZE GUARD

Optional	€		Description	Typology	Suitable for
PAR2L	484,00	2	Glass sneeze guard	Standard	2x1/1 GN
PAR2H	543,00	3		"Kid-service" opening	
PAR3L	508,00	2		Standard	3x1/1 GN
PAR3H	572,00	3		"Kid-service" opening	

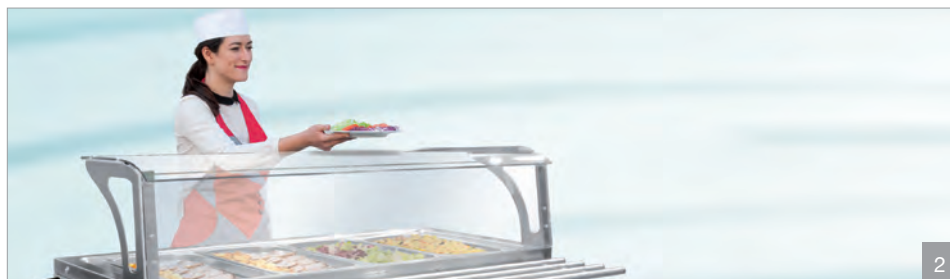

TRAY SLIDE SHELF

Optional	€	Description	Suitable for
ME2	145,00	Tray slide shelf, long side	2x1/1 GN
ME3	159,00		3x1/1 GN



BAIN-MARIE CUPBOARD TROLLEYS - SEPARATE WELLS LOWER COMPARTMENTS WITH PRESSED RUNNERS

- AISI 304 stainless steel sheet construction, brushed finish
- Polyurethane foam insulation panels
- Heat-proof pushing handles
- Separate Bain-Marie wells in pressed steel sheet with no sharp edges for up to 20 cm deep GN pans (not included)
- Separate Bain-Marie drain taps
- Separate heated or neutral lower compartments with no-sharp edges (compliant with H1 hygiene system), with independent thermostats, insulated 270° opening side doors, with magnet (to keep the doors open). N. 6 pairs of "pressed" runners suitable for containers 1/1 GN (or submultiples) spaced 5.5 cm

- Mains supply: 230V, 50/60 Hz, single-phase
- Bain-marie heating with heating element outside the well
- Dry heating: details and quotes upon request
- IPX5 digital control panel supplied as standard with independent thermostatic control - one thermostat for each heated well/compartment .
- 3-mt long coiled power cable, SCHUKO plug
- All round grey non marking rubber bumpers
- 2 Fixed and 2 braked swivel castors with heavy-duty brackets, ø 16 cm; grey non marking rubber tread on centre with roller bearing hub

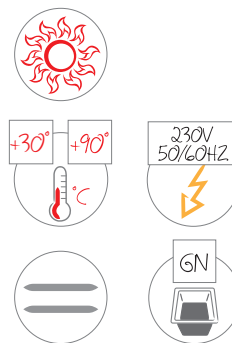

Optional + accessories: see pp. 130-131

Optional Gastronorms: see pp. 132-133



Note: IPX5 digital control panel is supplied as standard in the Bain-Marie trolleys with pressed runners ("GS" range)



Art. 7375A3-GS-E-C3







☰ = neutral ☀ = hot

Article	€	GN	Lower compartments	Power	Max dim. cm
7370A0-GS	3.442,00	2x1/1	☰ ☰	1200W	95x72x96 h
7370A1-GS	3.567,00		☰ ☀	1600W	
7370A2-GS	3.694,00		☀ ☀	2000W	
7375A0-GS	4.522,00	3x1/1	☰ ☰ ☰	1800W	134x72x96 h
7375A1-GS	4.720,00		☰ ☰ ☀	2200W	
7375A2-GS	4.846,00		☰ ☀ ☀	2600W	
7375A3-GS	4.972,00		☀ ☀ ☀	3000W	

Optional	€	📷	Description	Suitable for
E	60,00	1	Set of 4 resilient wheels, 2 with brake for uneven floors / outdoor use	All articles 

LID

- Insulated lids, when open they can be used as support
- AISI 304 stainless steel sheet construction, brushed finish

Optional	€	Description	Typology	Suitable for		
C2	634,00	Lids	opening to 180°	2x1/1 GN		
C3	670,00			3x1/1 GN		
L2	662,00		opening to 2/3 + 1/3	2x1/1 GN		
L3	737,00			3x1/1 GN		
S2	1.772,00		sliding	2x1/1 GN		
S3	1.963,00			3x1/1 GN		

SNEEZE GUARD

Optional	€		Description	Typology	Suitable for
PAR2L	484,00	2	Glass sneeze guard	Standard	2x1/1 GN
PAR2H	543,00	3		"Kid-service" opening	
PAR3L	508,00	2		Standard	3x1/1 GN
PAR3H	572,00	3		"Kid-service" opening	

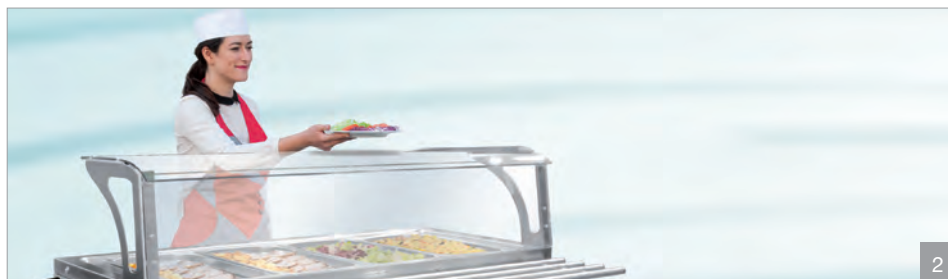

TRAY SLIDE SHELF

Optional	€	Description	Suitable for
ME2	145,00	Tray slide shelf, long side	2x1/1 GN
ME3	159,00		3x1/1 GN



BAIN-MARIE CUPBOARD TROLLEYS - SINGLE WELL SINGLE NEUTRAL LOWER COMPARTMENT

- AISI 304 stainless steel sheet construction, brushed finish
- Polyurethane foam insulation panels
- Heat-proof pushing handles
- Single Bain-Marie well in pressed steel sheet with no sharp edges for up to 20 cm-deep GN pans (not included)
- Bain-Marie drain tap
- Single lower neutral compartment with up-and-over door
- Mains supply: 230V, 50/60 Hz, single-phase
- Bain-marie heating with heating element outside the well
- Dry heating: details and quotes upon request
- Control panel with mechanical thermostatic control
- 3-mt long coiled power cable, SCHUKO plug
- All round grey non marking rubber bumpers
- 2 Fixed and 2 braked swivel castors with heavy-duty brackets, ø 16 cm; grey non marking rubber tread on centre with roller bearing hub



Optional + accessories: see pp. 130-131

Optional Gastronorms: see pp. 132-133



Art. 7365A

☰ = neutral

Article	€	GN	Lower compartment	Power	Max dim. cm
7360A	2.179,00	2/1	☰	1200W	95x72x96 h
7365A	2.543,00	3/1		1500W	134x72x96 h
7368A	2.974,00	4/1		2400W	172x72x96 h



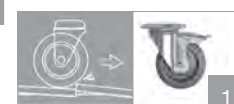



Optional	€	📷	Description	Suitable for
E	60,00	1	Set of 4 resilient wheels, 2 with brake for uneven floors / outdoor use	All articles



OPTIONAL LIDS, SNEEZE GUARDS AND SHELVES

LID

- Insulated lids, when open they can be used as support
- AISI 304 stainless steel sheet construction, brushed finish

Optional	€	Description	Typology	Suitable for		
C2	634,00	Lids	opening to 180°	2x1/1 GN		
C3	670,00			3x1/1 GN		
L2	662,00		opening to 2/3 + 1/3	2x1/1 GN		
L3	737,00			3x1/1 GN		
S2	1.772,00		sliding	2x1/1 GN		
S3	1.963,00			3x1/1 GN		

SNEEZE GUARD

Optional	€		Description	Typology	Suitable for
PAR2L	484,00	2	Glass sneeze guard	Standard	2x1/1 GN
PAR2H	543,00	3		"Kid-service" opening	
PAR3L	508,00	2		Standard	3x1/1 GN
PAR3H	572,00	3		"Kid-service" opening	
PAR4L	573,00	2		Standard	4x1/1 GN
PAR4H	586,00	3		"Kid-service" opening	



TRAY SLIDE SHELF

Optional	€	Description	Suitable for
ME2	145,00	Tray slide shelf, long side	2x1/1 GN
ME3	159,00		3x1/1 GN
ME4	205,00		4x1/1 GN



BAIN-MARIE CUPBOARD TROLLEYS - SINGLE WELL SEPARATE NEUTRAL AND HEATED LOWER COMPARTMENTS WITH "C"- SHAPED RUNNERS

- AISI 304 stainless steel sheet construction, brushed finish
- Polyurethane foam insulation panels
- Heat-proof pushing handles
- Single Bain-Marie well in pressed steel sheet with no sharp edges for up to 20 cm-deep GN pans (not included)
- Bain-Marie drain tap
- Separate heated or neutral lower compartments with independent thermostats, insulated up-and-over doors. N. 4 pairs of "C"-shaped runners suitable for containers 1/1 GN (or submultiples) spaced 7.6 cm

- Mains supply: 230V, 50/60 Hz, single-phase
- Bain-marie heating with heating element outside the well
- Dry heating: details and quotes upon request
- Control panel with independent mechanical thermostatic control - one thermostat for each heated well/compartment
- 3-mt long coiled power cable, SCHUKO plug
- All round grey non marking rubber bumpers
- 2 Fixed and 2 braked swivel castors with heavy-duty brackets, ø 16 cm; grey non marking rubber tread on centre with roller bearing hub

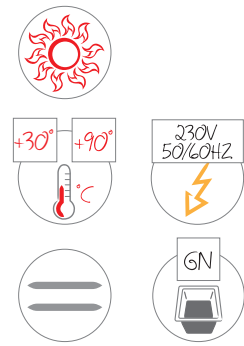

Optional + accessories: see pp. 130-131

Optional Gastronorms: see pp. 132-133

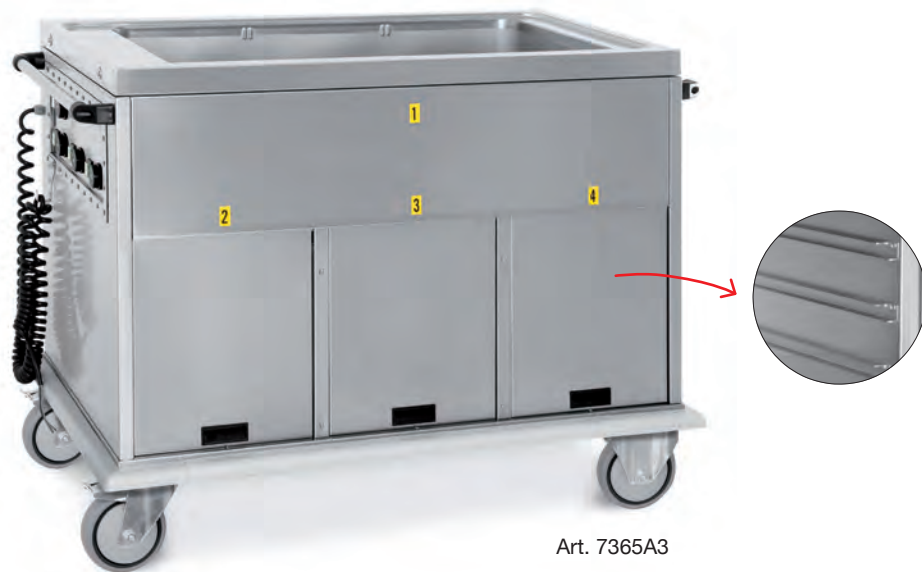

Art. 7365A3

☰ = neutral ☀ = hot

Article	€	GN	Lower compartments	Power	Max dim. cm
7360A0	2.741,00	2/1	☰ ☰	1200W	95x72x96 h
7360A1	2.850,00		☰ ☀	1600W	
7360A2	2.959,00		☀ ☀	2000W	
7365A0	3.417,00	3/1	☰ ☰ ☰	1500W	134x72x96 h
7365A1	3.581,00		☰ ☰ ☀	1900W	
7365A2	3.686,00		☰ ☀ ☀	2300W	
7365A3	3.790,00		☀ ☀ ☀	2700W	
7368A0	4.232,00	4/1	☰ ☰ ☰ ☰	2400W	172x72x96 h
7368A1	4.341,00		☰ ☰ ☰ ☀	2800W	
7368A2	4.450,00		☰ ☰ ☀ ☀	3200W	
7368A3	4.560,00		☰ ☀ ☀ ☀	3600W	
7368A4	4.669,00		☀ ☀ ☀ ☀	4000W	



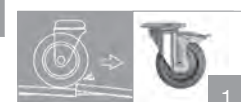



Optional	€	📷	Description	Suitable for
E	60,00	1	Set of 4 resilient wheels, 2 with brake for uneven floors / outdoor use	All articles



OPTIONAL LIDS, SNEEZE GUARDS AND SHELVES

LID

- Insulated lids, when open they can be used as support
- AISI 304 stainless steel sheet construction, brushed finish

Optional	€	Description	Typology	Suitable for		
C2	634,00	Lids	opening to 180°	2x1/1 GN		
C3	670,00			3x1/1 GN		
L2	662,00		opening to 2/3 + 1/3	2x1/1 GN		
L3	737,00			3x1/1 GN		
S2	1.772,00		sliding	2x1/1 GN		
S3	1.963,00			3x1/1 GN		

SNEEZE GUARD

Optional	€		Description	Typology	Suitable for
PAR2L	484,00	2	Glass sneeze guard	Standard	2x1/1 GN
PAR2H	543,00	3		"Kid-service" opening	
PAR3L	508,00	2		Standard	3x1/1 GN
PAR3H	572,00	3		"Kid-service" opening	
PAR4L	573,00	2		Standard	4x1/1 GN
PAR4H	586,00	3		"Kid-service" opening	



TRAY SLIDE SHELF

Optional	€	Description	Suitable for
ME2	145,00	Tray slide shelf, long side	2x1/1 GN
ME3	159,00		3x1/1 GN
ME4	205,00		4x1/1 GN



BAIN-MARIE CUPBOARD TROLLEYS - SINGLE WELL SEPARATE MIXED LOWER COMPARTMENTS WITH "C"- SHAPED RUNNERS

- AISI 304 stainless steel sheet construction, brushed finish
- Polyurethane foam insulation panels
- Heat-proof pushing handles
- Single Bain-Marie well in pressed steel sheet with no sharp edges for up to 20 cm-deep GN pans (not included)
- Bain-Marie drain tap
- Separate heated, refrigerated or neutral lower compartments with independent thermostats, insulated up-and-over doors. N. 4 pairs of "C"-shaped runners suitable for containers 1/1 GN (or submultiples) spaced 7.6 cm
- Mains supply: 230V, 50 Hz (60 Hz upon request), single-phase
- Bain-marie heating with heating element outside the well
- Dry heating: details and quotes upon request
- Ventilated refrigeration +4°C+10°C
- IPX5 digital control panel supplied as standard with independent thermostatic control - one thermostat for the well and for each heated or refrigerated compartment
- 3-mt long coiled power cable, SCHUKO plug
- All round grey non marking rubber bumpers
- 2 Fixed and 2 braked swivel castors with heavy-duty brackets, ø 16 cm; grey non marking rubber tread on centre with roller bearing hub

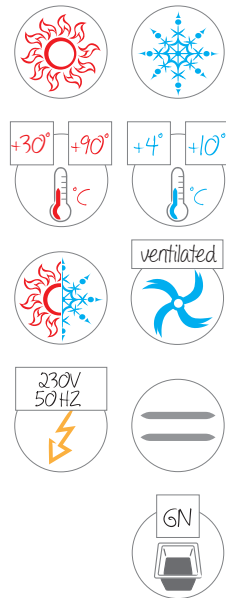

Optional + accessories: see pp. 130-131

Optional Gastronorms: see pp. 132-133

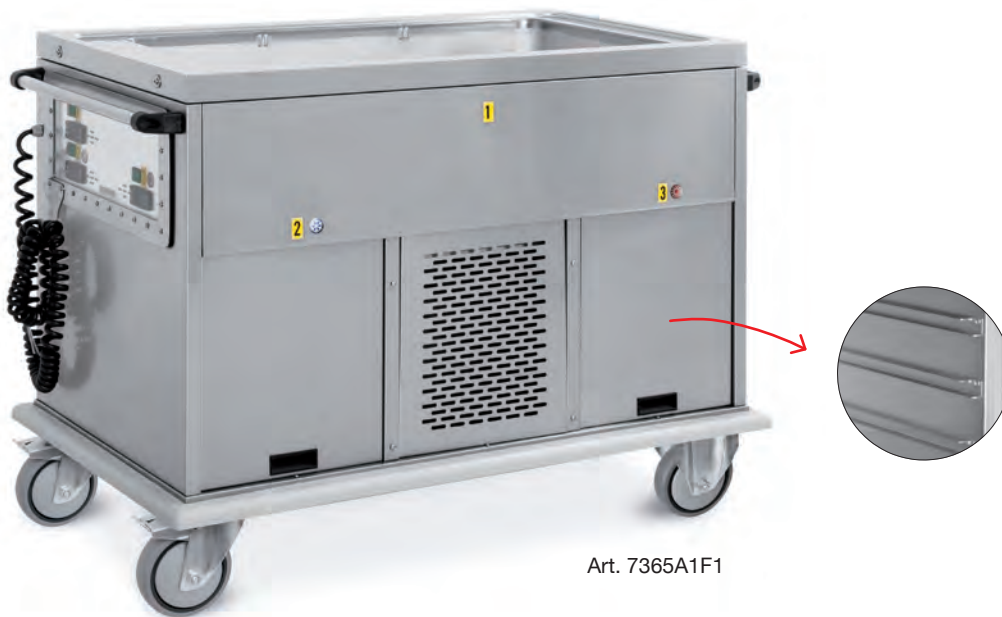

Art. 7365A1F1



Note: IPX5 digital control panel is supplied as standard in the Bain-Marie trolleys with refrigerated compartments

☰ = neutral ☀ = hot ❄ = cold

Article	€	GN	Lower compartments	Power	Max dim. cm
7360A0F1	3.835,00	2/1	❄	1450W	95x72x96 h
7365A0F2	4.359,00	3/1	❄ ❄	1800W	134x72x96 h
7365A1F1	4.695,00		☀ ❄	2150W	
7368A0F2	5.216,00	4/1	☰ ❄ ❄	2700W	172x72x96 h
7368A1F2	5.395,00		☀ ❄ ❄	3100W	
7368A2F1	5.690,00		☀ ☀ ❄	3600W	







Optional	€	📷	Description	Suitable for
E	60,00	1	Set of 4 resilient wheels, 2 with brake for uneven floors / outdoor use	All articles



OPTIONAL LIDS, SNEEZE GUARDS AND SHELVES

LID

- Insulated lids, when open they can be used as support
- AISI 304 stainless steel sheet construction, brushed finish

Optional	€	Description	Typology	Suitable for		
C2	634,00	Heat-proof lids	opening to 180°	2x1/1 GN		
C3	670,00			3x1/1 GN		
L2	662,00		opening to 2/3 + 1/3	2x1/1 GN		
L3	737,00			3x1/1 GN		
S2	1.772,00		sliding	2x1/1 GN		
S3	1.963,00			3x1/1 GN		

SNEEZE GUARD

Optional	€		Description	Typology	Suitable for
PAR2L	484,00	2	Glass sneeze guard	Standard	2x1/1 GN
PAR2H	543,00	3		"Kid-service" opening	
PAR3L	508,00	2		Standard	3x1/1 GN
PAR3H	572,00	3		"Kid-service" opening	
PAR4L	573,00	2		Standard	4x1/1 GN
PAR4H	586,00	3		"Kid-service" opening	

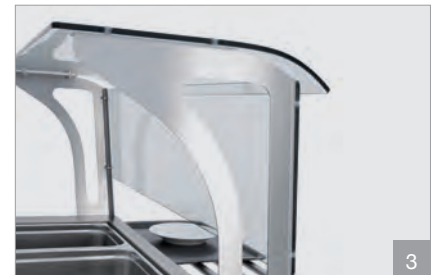

TRAY SLIDE SHELF

Optional	€	Description	Suitable for
ME2	145,00	Tray slide shelf, long side	2x1/1 GN
ME3	159,00		3x1/1 GN
ME4	205,00		4x1/1 GN



BAIN-MARIE CUPBOARD TROLLEYS - SEPARATE WELLS SINGLE NEUTRAL LOWER COMPARTMENT

- AISI 304 stainless steel sheet construction, brushed finish
- Polyurethane foam insulation panels
- Heat-proof pushing handles
- Separate Bain-Marie wells in pressed steel sheet with no sharp edges for up to 20 cm deep GN pans (not included)
- Separate Bain-Marie drain taps
- Single lower neutral compartment with up-and-over door
- Mains supply: 230V, 50/60 Hz, single-phase
- Bain-marie heating with heating element outside the well
- Dry heating: details and quotes upon request
- Control panel with independent mechanical adjustable thermostatic control, one thermostat for each well
- 3-mt long coiled power cable, SCHUKO plug
- All round grey non marking rubber bumpers
- 2 Fixed and 2 braked swivel castors with heavy-duty brackets, ø 16 cm; grey non marking rubber tread on centre with roller bearing hub



Optional + accessories: see pp. 130-131



Optional Gastronorms: see pp. 132-133



Art. 7375A







 = neutral

Article	€	GN	Lower compartment	Power	Max dim. cm
7370A	2.412,00	2x1/1		1200W	95x72x96 h
7375A	2.997,00	3x1/1		1800W	134x72x96 h
7378A	3.573,00	4x1/1		2400W	172x72x96 h

Optional	€		Description	Suitable for
E	60,00	1	Set of 4 resilient wheels, 2 with brake for uneven floors / outdoor use	All articles 

LID

- Insulated lids, when open they can be used as support
- AISI 304 stainless steel sheet construction, brushed finish

Optional	€	Description	Typology	Suitable for		
C2	634,00	Lids	opening to 180°	2x1/1 GN		
C3	670,00			3x1/1 GN		
L2	662,00		opening to 2/3 + 1/3	2x1/1 GN		
L3	737,00			3x1/1 GN		
S2	1.772,00		sliding	2x1/1 GN		
S3	1.963,00			3x1/1 GN		

SNEEZE GUARD

Optional	€		Description	Typology	Suitable for
PAR2L	484,00	2	Glass sneeze guard	Standard	2x1/1 GN
PAR2H	543,00	3		"Kid-service" opening	
PAR3L	508,00	2		Standard	3x1/1 GN
PAR3H	572,00	3		"Kid-service" opening	
PAR4L	573,00	2		Standard	4x1/1 GN
PAR4H	586,00	3		"Kid-service" opening	



TRAY SLIDE SHELF

Optional	€	Description	Suitable for
ME2	145,00	Tray slide shelf, long side	2x1/1 GN
ME3	159,00		3x1/1 GN
ME4	205,00		4x1/1 GN



BAIN-MARIE CUPBOARD TROLLEYS - SEPARATE WELLS SEPARATE NEUTRAL AND HEATED LOWER COMPARTMENTS WITH "C"- SHAPED RUNNERS

- AISI 304 stainless steel sheet construction, brushed finish
- Polyurethane foam insulation panels
- Heat-proof pushing handles
- Separate Bain-Marie wells in pressed steel sheet with no sharp edges for up to 20 cm deep GN pans (not included)
- Separate Bain-Marie drain taps
- Separate heated or neutral lower compartments with independent thermostats, insulated up-and-over doors. N. 4 pairs of "C"-shaped runners suitable for containers 1/1 GN (or submultiples) spaced 7.6 cm

- Mains supply: 230V, 50/60 Hz, single-phase
- Bain-marie heating with heating element outside the well
- Dry heating: details and quotes upon request
- Control panel with independent mechanical adjustable thermostatic control, one thermostat for each heated well/compartment
- 3-mt long coiled power cable, SCHUKO plug
- All round grey non marking rubber bumpers
- 2 Fixed and 2 braked swivel castors with heavy-duty brackets, ø 16 cm; grey non marking rubber tread on centre with roller bearing hub

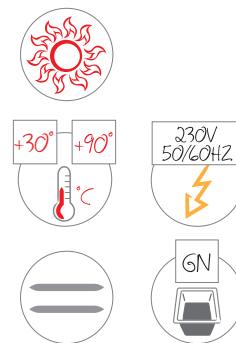

Optional + accessories: see pp. 130-131

Optional Gastronorms: see pp. 132-133

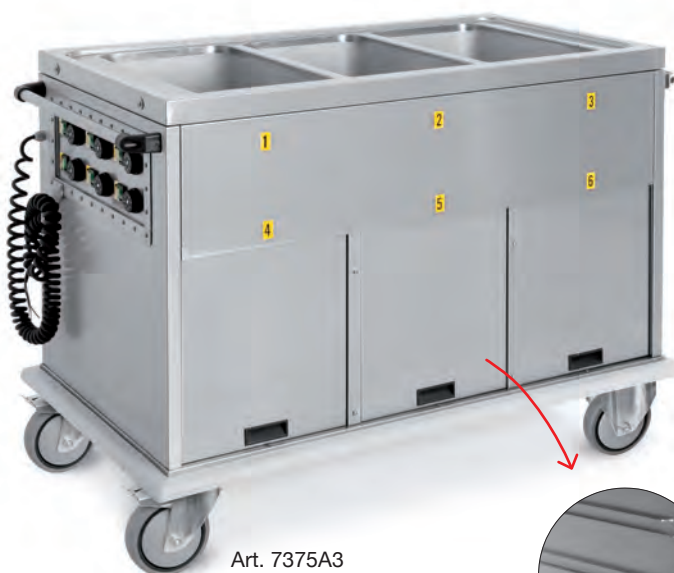

Art. 7375A3

☰ = neutral ☀ = hot







Article	€	GN	Lower compartments	Power	Max dim. cm
7370A0	2.976,00	2x1/1	☰ ☰	1200W	95x72x96 h
7370A1	3.084,00		☰ ☀	1600W	
7370A2	3.194,00		☀ ☀	2000W	
7375A0	3.909,00	3x1/1	☰ ☰ ☰	1800W	134x72x96 h
7375A1	4.080,00		☰ ☰ ☀	2200W	
7375A2	4.189,00		☰ ☀ ☀	2600W	
7375A3	4.298,00		☀ ☀ ☀	3000W	
7378A0	4.832,00	4x1/1	☰ ☰ ☰ ☰	2400W	172x72x96 h
7378A1	4.939,00		☰ ☰ ☰ ☀	2800W	
7378A2	5.050,00		☰ ☰ ☀ ☀	3200W	
7378A3	5.159,00		☰ ☀ ☀ ☀	3600W	
7378A4	5.268,00		☀ ☀ ☀ ☀	4000W	

Optional	€	📷	Description	Suitable for
E	60,00	1	Set of 4 resilient wheels, 2 with brake for uneven floors / outdoor use	All articles



LID

- Insulated lids, when open they can be used as support
- AISI 304 stainless steel sheet construction, brushed finish

Optional	€	Description	Typology	Suitable for		
C2	634,00	Lids	opening to 180°	2x1/1 GN		
C3	670,00			3x1/1 GN		
L2	662,00		opening to 2/3 + 1/3	2x1/1 GN		
L3	737,00			3x1/1 GN		
S2	1.772,00		sliding	2x1/1 GN		
S3	1.963,00			3x1/1 GN		

SNEEZE GUARD

Optional	€		Description	Typology	Suitable for
PAR2L	484,00	2	Glass sneeze guard	Standard	2x1/1 GN
PAR2H	543,00	3		"Kid-service" opening	
PAR3L	508,00	2		Standard	3x1/1 GN
PAR3H	572,00	3		"Kid-service" opening	
PAR4L	573,00	2		Standard	4x1/1 GN
PAR4H	586,00	3		"Kid-service" opening	

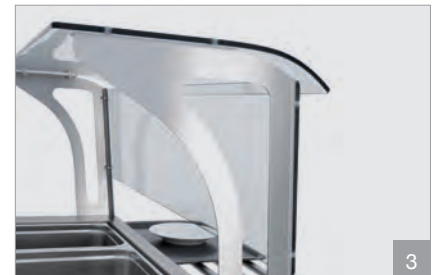

TRAY SLIDE SHELF

Optional	€	Description	Suitable for
ME2	145,00	Tray slide shelf, long side	2x1/1 GN
ME3	159,00		3x1/1 GN
ME4	205,00		4x1/1 GN



BAIN-MARIE CUPBOARD TROLLEYS - SEPARATE WELLS SEPARATE MIXED LOWER COMPARTMENTS WITH "C"-SHAPED RUNNERS

- AISI 304 stainless steel sheet construction, brushed finish
- Polyurethane foam insulation panels
- Heat-proof pushing handles
- Separate Bain-Marie wells in pressed steel sheet with no sharp edges for up to 20 cm deep GN pans (not included)
- Separate Bain-Marie drain taps
- Separate heated, refrigerated or neutral lower compartments with independent thermostats, insulated up-and-over doors. N. 4 pairs of "C"-shaped runners suitable for containers 1/1 GN (or submultiples) spaced 7.6 cm
- Mains supply: 230V, 50 Hz (60 Hz upon request), single-phase
- Bain-marie heating with heating element outside the well
- Dry heating: details and quotes upon request
- Ventilated refrigeration +4°C+10°C
- IPX5 digital control panel supplied as standard with independent thermostatic control - one thermostat for each well and for each heated or refrigerated compartment
- 3-mt long coiled power cable, SCHUKO plug
- All round grey non marking rubber bumpers
- 2 Fixed and 2 braked swivel castors with heavy-duty brackets, ø 16 cm; grey non marking rubber tread on centre with roller bearing hub

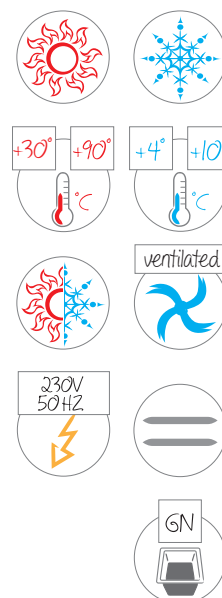

Optional + accessories: see pp. 130-131

Optional Gastronorms: see pp. 132-133



Art. 7375A1F1



Note: IPX5 digital control panel is supplied as standard in the Bain-Marie trolleys with refrigerated compartments

☰ = neutral ☀ = hot ❄ = cold

Article	€	GN	Lower compartments	Power	Max dim. cm
7370A0F1	4.068,00	2x1/1	❄	1450W	95x72x96 h
7375A0F2	4.892,00	3x1/1	❄ ❄	2100W	134x72x96 h
7375A1F1	5.242,00		☀ ❄	2450W	
7378A0F2	5.816,00	4x1/1	☰ ❄ ❄	2700W	172x72x96 h
7378A1F2	5.995,00		☀ ❄ ❄	3100W	
7378A2F1	6.289,00		☀ ☀ ❄	3600W	



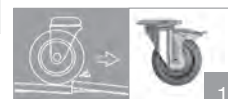



Optional	€	📷	Description	Suitable for
E	60,00	1	Set of 4 resilient wheels, 2 with brake for uneven floors / outdoor use	All articles



OPTIONAL LIDS, SNEEZE GUARDS AND SHELVES

LID

- Insulated lids, when open they can be used as support
- AISI 304 stainless steel sheet construction, brushed finish

Optional	€	Description	Typology	Suitable for		
C2	634,00	Lids	opening to 180°	2x1/1 GN		
C3	670,00			3x1/1 GN		
L2	662,00		opening to 2/3 + 1/3	2x1/1 GN		
L3	737,00			3x1/1 GN		
S2	1.772,00		sliding	2x1/1 GN		
S3	1.963,00			3x1/1 GN		

SNEEZE GUARD

Optional	€		Description	Typology	Suitable for
PAR2L	484,00	2	Glass sneeze guard	Standard	2x1/1 GN
PAR2H	543,00	3		"Kid-service" opening	
PAR3L	508,00	2		Standard	3x1/1 GN
PAR3H	572,00	3		"Kid-service" opening	
PAR4L	573,00	2		Standard	4x1/1 GN
PAR4H	586,00	3		"Kid-service" opening	

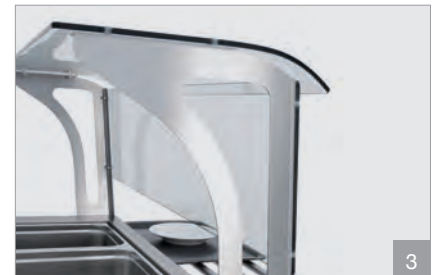

TRAY SLIDE SHELF

Optional	€	Description	Suitable for
ME2	145,00	Tray slide shelf, long side	2x1/1 GN
ME3	159,00		3x1/1 GN
ME4	205,00		4x1/1 GN



ACCESSORIES AND OPTIONAL PARTS

OPTIONAL CONTROL PANEL

• Control panel with IPX5 protection (*) ON/OFF digital switch thermostatic control

(*) The IPX5 control panel is supplied as standard in the Bain-Marie trolleys featuring one or more lower refrigerated compartments or lower compartments with pressed runners ("GS" range).



Article	T0100	T0102	T0104	T0106	T0108	T0110	T0112	T0114	T0116
	101,00 €	143,00 €	193,00 €	241,00 €	227,00 €	143,00 €	185,00 €	235,00 €	185,00 €
7360A	•								
7365A	•								
7368A	•								
7360A0	•								
7360A1		•							
7360A2			•						
7365A0	•								
7365A1		•							
7365A2			•						
7365A3				•					
7368A0	•								
7368A1		•							
7368A2			•						
7368A3				•					
7368A4					•				
7370A						•			
7375A									•
7370A0						•			
7370A1							•		
7370A2								•	
7375A0									•

OPTIONAL CONTROL PANEL

- Control panel with IPX5 protection (*) ON/OFF digital switch thermostatic control
- (*) The IPX5 control panel is supplied as standard in the Bain-Marie trolleys featuring one or more lower refrigerated compartments or lower compartments with pressed runners ("GS" range).



Article	T0118	T0120	T0122	T0124	T0126	T0128	T0130	T0132	
	227,00 €	277,00 €	326,00 €	210,00 €	249,00 €	297,00 €	342,00 €	387,00 €	
7378A				•					
7375A1	•								
7375A2		•							
7375A3			•						
7378A0				•					
7378A1					•				
7378A2						•			
7378A3							•		
7378A4								•	

OPTIONAL POWER PLUG

Optional	€	Description
T200	47,00	Power plug 2P+GND-6h/250V - 16A - IP67 (IEC 309)



OPTIONAL TOW BAR

Optional	€	Description
T-2018	725,00	Tow bar with coupler for all bain-marie cupboard trolleys Note: this item is not compatible with accessory sneeze guard: Art. PAR2L - PAR2H - PAR3L - PAR3H - PA4L - PAR4H



ACCESSORY EUTECTIC PLATE

Accessories	€	Description
T0030	133,00	GN eutectic plate (-10 °C) for neutral lower compartments



STAINLESS STEEL GASTRONORM CONTAINERS, LIDS AND DIVIDERS

Bain-Marie units for meal distribution, as well as self-service buffet trolleys, Bain-Marie trolleys and a few types of hotplates are designed in compliance with Gastronorm size standards.

Stainless steel Gastronorm containers are widely used in the catering industry for food storage. Lids are also available. Dividers are needed to fit a number of containers into the trolley wells.



GASTRONORM CONTAINERS SIZES

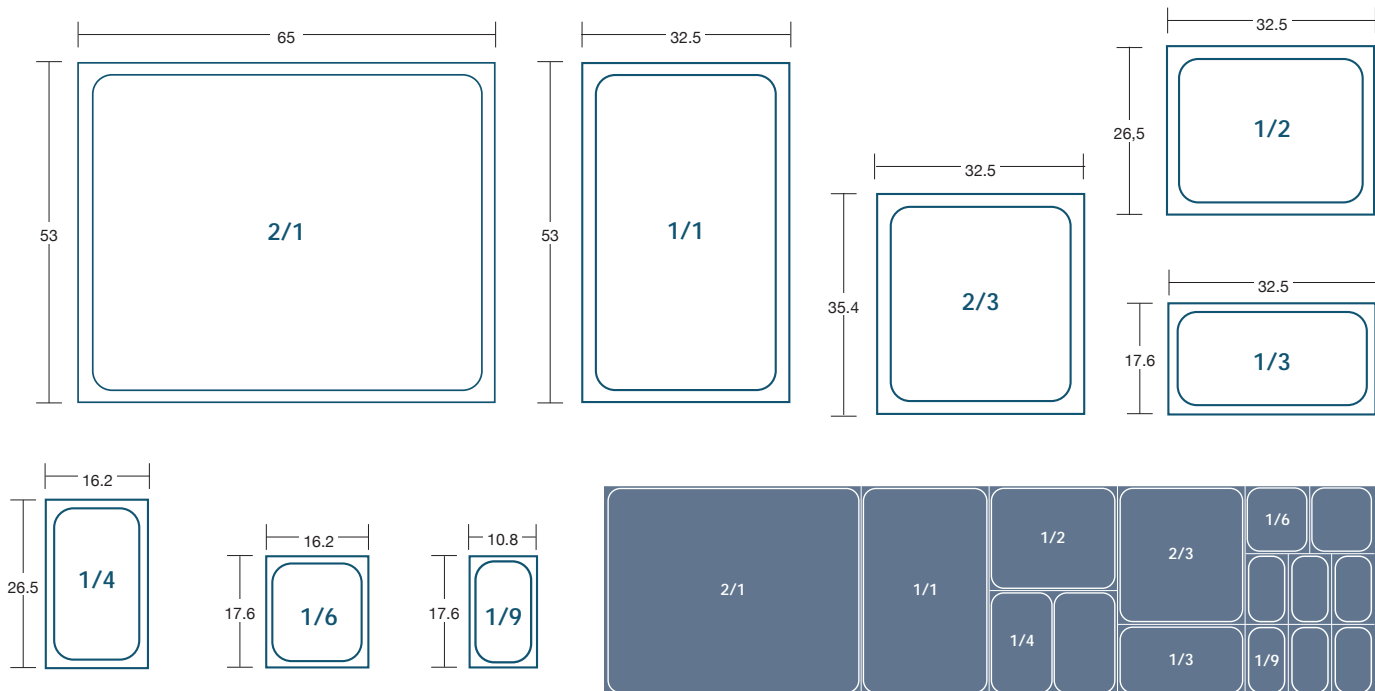

LIDS FOR GASTRONORM CONTAINERS

Article	€	GN	Dim. max cm
B0190	20,00	1/1	32.5x53
B0290	17,00	2/3	32.5x35.4
B0390	13,00	1/2	26.5x32.5
B0490	11,00	1/3	17.6x32.5
B0590	9,00	1/4	26.5x16.2
B0690	8,00	1/6	17.6x16.2

DIVIDERS FOR GASTRONORM CONTAINERS

Article	€	GN	Dim. max cm
B0002	11,00	1/1	53
B0004	9,00	1/2	32.5

STAINLESS STEEL GASTRONORMS

Article	€	GN	H cm	Max dim. cm
B0010	48,00	2/1	2	65x53
B0020	53,00		4	
B0030	57,00		6.5	
B0040	74,00		10	
B0050	101,00		15	
B0060	115,00		20	
B0110	23,00	1/1	2	32.5x53
B0120	26,00		4	
B0130	30,00		6.5	
B0140	36,00		10	
B0150	51,00		15	
B0160	61,00		20	
B0210	15,00	2/3	2	32.5x35.4
B0220	20,00		4	
B0230	23,00		6.5	
B0240	30,00		10	
B0250	36,00		15	
B0260	42,00		20	
B0310	13,00	1/2	2	26.5x32.5
B0320	15,00		4	
B0330	18,00		6.5	
B0340	24,00		10	
B0350	30,00		15	
B0360	36,00		20	
B0410	10,00	1/3	2	17.6x32.5
B0420	13,00		4	
B0430	15,00		6.5	
B0440	19,00		10	
B0450	25,00		15	
B0460	28,00		20	
B0510	8,00	1/4	2	26.5x16.2
B0520	11,00		4	
B0530	12,00		6.5	
B0540	17,00		10	
B0550	20,00		15	
B0560	27,00		20	
B0630	13,00	1/6	6.5	17.6x16.2
B0640	15,00		10	
B0650	19,00		15	
B0660	32,00		20	
B0730	11,00	1/9	6.5	17.6x10.8
B0740	15,00		10	





Tableware handling trolleys

Knife sterilizers

Tray / pan trolleys



UV KNIFE STERILIZERS _____ 136



PLATE WARMER CABINETS _____ 137



PLATE STACKERS _____ 138



PLATE / TRAY / GLASS TROLLEYS _____ 140



CROCKERY AND GLASSWARE DRAINING TROLLEYS _____ 142



HANGING DRAINERS _____ 144



TRAY/LID DRAINING TROLLEYS _____ 145



RACK STACKING TROLLEYS _____ 146



GN - EN TRAY TROLLEYS _____ 148



UNIVERSAL TRAY TROLLEYS _____ 154



GN - EN TRAY TROLLEYS _____ 160



CONTAINER TROLLEYS _____ 161



NEUTRAL TRAY/PAN MOBILE CUPBOARDS _____ 167



INSULATED HEATED/REFRIGERATED TRAY/PAN CUPBOARDS _____ 168



NEUTRAL - INSULATED - HEATED TRAY/PAN CUPBOARDS _____ 174



UV KNIFE STERILIZERS

- Stainless steel structure
- Methacrylate door with anti UV dispersion and magnetic closure
- Steel wire knife rack
- Safety microswitch that automatically turns the lamp OFF when opening the door
- ON/OFF switch
- Adjustable timer: 0-60 minutes
- Mains supply: 230V, 50 Hz, single-phase

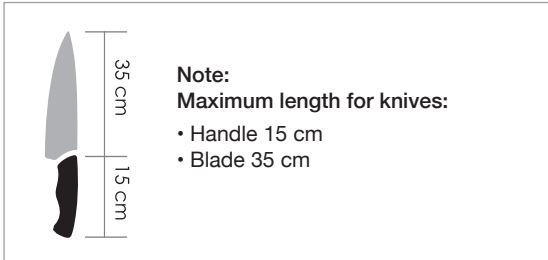

Art. 7502

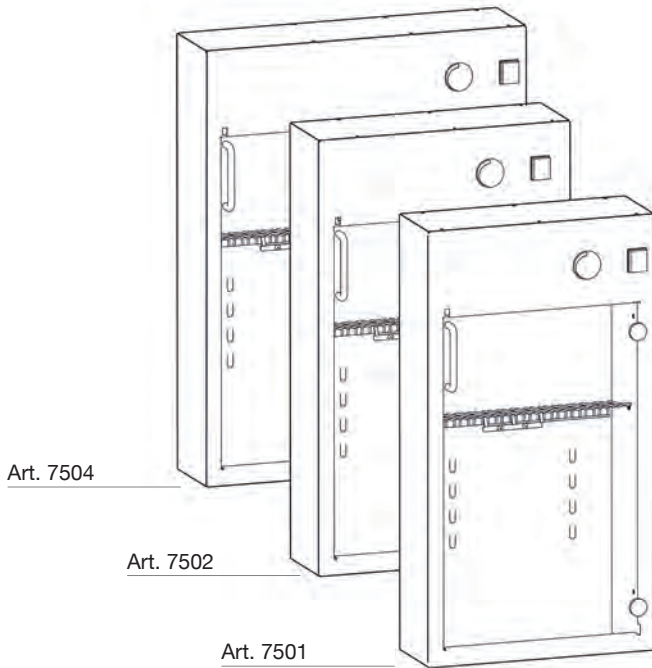

Art. 7504

Art. 7502

Art. 7501

Article	€	Knife qty.	Power	Max dim. cm
7501	289,00	12	16W	36x13x67 h
7502	316,00	14		40x13x67 h
7504	350,00	20		51x13x67 h

PLATE WARMER CABINETS

- Double skinned, stainless steel sheet construction insulated with expanded polyurethane panels
- Insulated double skinned hinged front doors opening to 180°, with mechanical key lock
- Internal perforated height-adjustable shelves
- Static heating
- ON/OFF switch with warning light
- Adjustable thermostat
- Mains supply: 230V, 50/60 Hz, single-phase
- Adjustable feet (Art. 9630)
- Swivel castors (Art. 9660 - 96100 - 96120)

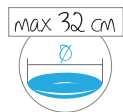
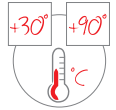

Art. 9660



Art. 96120-F



Art. 9630

Article	€	Plate cap.	Max plate Ø cm	Doors	Shelves	Power	Max dim. cm
9630	750,00	30	32	1	1	400W	42x46x58 h
9660	820,00	60			42x46x94 h		
96100	1.056,00	100		2	2	800W	77x46x80 h
96120	1.140,00	120					77x46x94 h
Optional	€		Description		Suitable for		
F	22,00	1	Set with 2 braked castors		9660 - 96100 - 96120		1

COUNTERTOP PLATE STACKERS

- Black epoxy powder painted steel construction
- White rilsan plastic coated steel plate supports
- Adjustable feet



24 plates

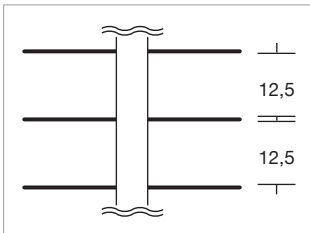

48 plates

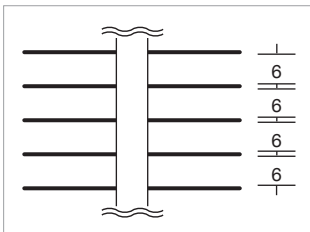

Art. 3019

Article	€	Plate capacity	Plate Ø cm	Max dim. cm
3020	261,00	48	18÷24	77x77x95 h
3021	273,00		24÷31	
3018	235,00	24	18÷24	
3019	239,00		24÷31	

Accessories	€	📷	Description	Suitable for
A0252	160,00	1	PVC cover with zipper	All articles



WHEELED PLATE STACKERS

- Black epoxy powder painted steel construction
- White rilsan plastic coated steel plate support
- Pushing handles
- Swivel castors, ø 12.5 cm, 2 with brake

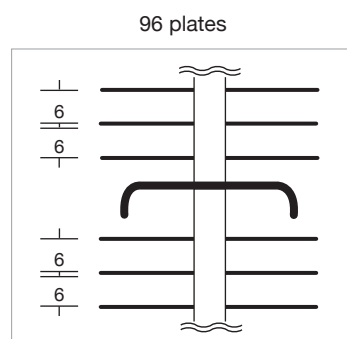
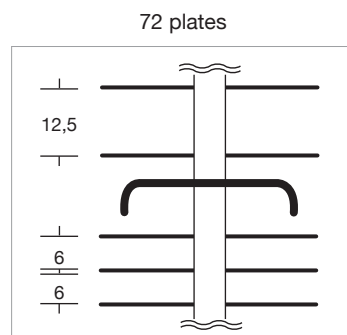
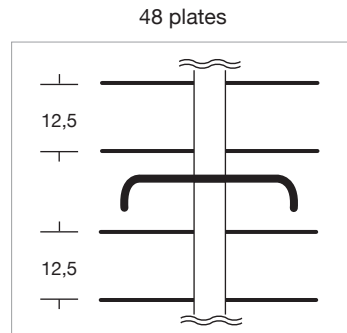

Art. 3011

Article	€	Plate capacity	Plate Ø cm	Max dim. cm
3008	503,00	48	18÷24	77x77x180 h
3009	548,00	72		
3010	535,00	96		
3013	500,00	48	24÷31	
3012	548,00	72		
3011	558,00	96		
Accessories	€	Description	Suitable for	
A0250	164,00	1 PVC cover with zipper	All articles	



PLATE / TRAY TROLLEYS

- AISI 304 stainless steel 2x2 cm square tube frame
- AISI 304 stainless steel sheet side panels
- Inclined base to prevent sliding
- Additional lower stainless steel shelf (depending on the model)
- Grey rubber ring buffers
- Swivel castors, ø 12.5 cm



Art. 1270-F



Art. 1272-F + A0255



Art. 1272-F

Article	€		Shelves	Max dim. cm
1270	410,00		1	84x51x91 h
1272	462,00		2	84x51x116 h

Optional	€	📷	Description	Suitable for
F	22,00	1	Set with 2 braked castors	All articles 

Accessories	€	📷	Description	Suitable for
A0254	116,00	2	PVC cover with zipper	1270
A0255	151,00			1272



- AISI 304 stainless steel 2x2 cm square tube frame
- AISI 304 stainless steel sheet side panels and base
- Inclined base to prevent from sliding
- AISI 304 stainless steel wire dividers (optional)
- Swivel castors, ø 12.5 cm, 2 with brake



Art. 1270PR-E + A0056(x2)



Art. 1270P + A0056(x2)

Article	€	Shelves	Max dim. cm
1270P	508,00	1	90x60x91 h
1270PR	613,00	2	90x60x102 h

Optional	€	Description	Suitable for
E	80,00	Set of 4 resilient castors, 2 with brake for uneven floors / outdoor use	All articles

Accessories	€	Description	Suitable for
A0056	54,00	AISI 304 stainless steel single removable wire divider	All articles
A0260	190,00	PVC cover with zipper	

CROCKERY AND GLASSWARE DRAINING TROLLEYS

- AISI 304 stainless steel 2x2 cm square tube frame, or 2.5x2.5 cm square tube frame (Art. 5034 - 5036 - 5038)
- Stainless steel sheet crockery racks with no sharp edges
- Removable thermoformed ABS glass racks with drip tray and watertight plug
- Swivel castors, ø 12.5 cm



Art. 5024-F



Art. 5020-F



Art. 5022-F

Article	€	Plate cap.	Plate Ø cm	Crockery racks	Glass racks	Max dim. cm
5002	587,00	180	16÷26	3	-	87x62x121 h
5004	591,00	120		2	1	
5006	594,00	60		1	2	
5020	636,00	216	16÷26	3	-	102x62x121 h
5022	630,00	144		2	1	
5024	626,00	72		1	2	
5034	668,00	216	16÷32	3	-	102x69x134 h
5036	663,00	144		2	1	
5038	658,00	72		1	2	

Optional	€	📷	Description	Suitable for
F	22,00	1	Set with 2 braked castors	All articles

Accessories	€	📷	Description	Suitable for
A0282	143,00	2	PVC cover with zipper	5002 - 5004 - 5006
A0284	155,00			5020 - 5022 - 5024
A0289	207,00			5034 - 5036 - 5038



1



2

CROCKERY AND GLASSWARE DRAINING TROLLEYS

- AISI 304 stainless steel 2x2 cm square tube frame
- Stainless steel sheet crockery racks with no sharp edges
- Removable thermoformed ABS glass racks with drip tray and watertight plug
- Swivel castors, ø 12.5 cm





Art. 5026-F



Art. 5032-F

Article	€	Plate cap.	Plate Ø cm	Crockery racks	Glass racks	Max dim. cm
5012	750,00	240	16÷26	4	-	87x62x159 h
5014	750,00	180		3	1	
5016	750,00	120		2	2	
5018	750,00	60		1	3	
5026	807,00	288	16÷26	4	-	102x62x159 h
5028	802,00	216		3	1	
5030	797,00	144		2	2	
5032	792,00	72		1	3	

Optional	€	📷	Description	Suitable for	📷
F	22,00	1	Set with 2 braked castors	All articles	 1
Accessories	€	📷	Description	Suitable for	📷
A0286	162,00	2	PVC cover with zipper	5012 - 5014 5016 - 5018	 2
A0288	177,00			5026 - 5028 5030 - 5032	

HANGING DRAINERS

- AISI 304 stainless steel 2x2 cm square tube frame
- Stainless steel sheet crockery racks with no sharp edges
- Stainless steel sheet glass racks with drip tray
- Hardware for wall-mounting not included

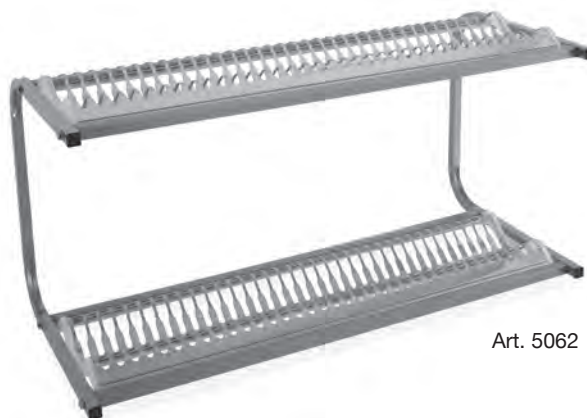

Art. 5062



Art. 5064



Art. 5066

Article	€	Plate cap.	Plate Ø	Crockery racks	Glass racks	Max dim. cm
5052	180,00	60	16÷32	2	-	83x42x48 h
5054	187,00	30		1	1	
5056	195,00	-		-	2	
5062	195,00	72	16÷32	2	-	98x42x48 h
5064	230,00	36		1	1	
5066	224,00	-		-	2	

TRAY / LID DRAINING TROLLEYS

- AISI 304 stainless steel 2.5x2.5 cm square tube frame
- Stainless steel wire dividers
- Thermoformed ABS lower drip tray with watertight plug
- Swivel castors, ø 12.5 cm



Art. 2264

Article	€		Tray/lid capacity	Max dim. cm
2264	767,00		60	102x62x143 h
Optional	€	📷	Description	
F	22,00	1	Set with 2 braked castors	
Accessories	€	Description		
A0270	233,00	PVC cover with zipper		



RACK STACKING TROLLEYS

- Linear polyethylene support with drain hole and plug (Art. 2205P - 2206P)
- Stainless steel base (Art. 2202P - 2203P - 2207P - 2208P)
- ABS plastic base (Art. 1837)
- Stainless steel handle (depending on the model)
- Swivel castors ø 9.5 cm
- Swivel castors ø 10 cm (Art. 1837)



Art. 2205P



Art. 2207P



Art. 2206P



Art. 2202P



Art. 1837

Article	€	Description	Material	Base dim. cm	Max dim. cm
2205P	161,00	Base with handle	Polyethylene	51x51	75x58x85 h
2206P	138,00	Base only			58x58x19 h
2207P	233,00	Base with handle	Stainless steel	51x51	61x52x95 h
2208P	224,00	Base only			52x52x19 h
2202P	242,00	Base with handle	Stainless steel	61x41	71x42x95 h
2203P	230,00	Base only			62x42x19 h
1837	81,00	Base only	Plastic	62x41	62x41x15.5 h

Optional	€	Image	Description	Suitable for	Image
F	10,00	1	Set with 2 braked castors	All articles (except art. 1837)	 1

- AISI 304 stainless steel 2x2 cm square tube frame with bolted cross-members
- Stainless steel sheet "L"-shaped runners
- Suitable for dishwasher glass rack (dim. 51x51 cm)
- Grey rubber ring buffers
- Swivel castors, ø 12.5 cm



Art. 1498.5

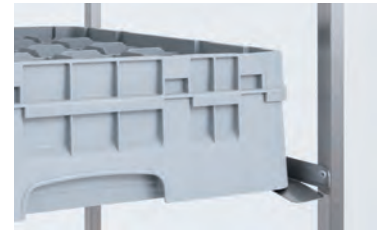

Runner detail

Article	€	Runner qty	Shelf-spacing cm	Max dim. cm
1498.5	294,00	5	30	64x60x184 h
1498.6	314,00	6	26	
1498.7	332,00	7	22	

Optional	€	📷	Description	Suitable for	
F	22,00	1	Set with 2 braked castors	All articles	1
Accessories	€		Description	Suitable for	
A0278	192,00		PVC cover with zipper	All articles	

GN / EN TRAY TROLLEYS

- AISI 304 stainless steel 2x2 cm square tube construction with bolted cross-members
- Stainless steel sheet "L"-shaped runners suitable for GN or EN trays (depending on the model)
- Grey rubber ring buffers
- Swivel castors, ø 12.5 cm



Art. 1475GN

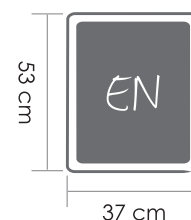
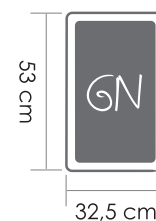

Article	€	Tray capacity	Runners	Shelf spacing cm	Max dim. cm
1470GN	321,00	10 GN 1/1	L	11	45x60x150 h
1472GN	353,00	12 GN 1/1			45x60x172 h
1475GN	489,00	20 GN 1/1			80x60x150 h
1477GN	539,00	24 GN 1/1			80x60x172 h
1480GN	649,00	30 GN 1/1			116x60x150 h
1482GN	726,00	36 GN 1/1			116x60x172 h
1470EN	321,00	10 EN			49x60x150 h
1472EN	353,00	12 EN			49x60x172 h
1475EN	489,00	20 EN			89x60x150 h
1477EN	539,00	24 EN			89x60x172 h
1480EN	649,00	30 EN			129x60x150 h
1482EN	726,00	36 EN			129x60x172 h

Optional	€	Description	Suitable for
F	22,00	1 Set with 2 braked castors	All articles
E	166,00	2 Set with 4 resilient castors, 2 with brake, for uneven floors / outdoor use	
Accessories	€	Description	Suitable for
A050GN	62,00	3 Removable stainless steel container (1 for each column)	GN models
A050EN	62,00		EN models



GN - EN TRAY TROLLEYS WITH AISI 304 STAINLESS STEEL PANELS

- AISI 304 stainless steel 2x2 cm square tube construction with bolted cross-members
- Stainless steel sheet "L"-shaped runners suitable for GN or EN trays (depending on the model)
- AISI 304 stainless steel sheet panels
- Grey rubber ring buffers
- Swivel castors, ø 12.5 cm

Stainless steel



Art. 1470GN-PI

• GN - EN TRAY TROLLEYS WITH PANELS ON 2 SIDES

Article	€	Tray capacity	Runners	Shelf spacing cm	Max dim. cm
1470GN-PI	460,00	10 GN 1/1	L	11	45x60x150 h
1472GN-PI	513,00	12 GN 1/1			45x60x172 h
1475GN-PI	628,00	20 GN 1/1			80x60x150 h
1477GN-PI	699,00	24 GN 1/1			80x60x172 h
1480GN-PI	789,00	30 GN 1/1			116x60x150 h
1482GN-PI	886,00	36 GN 1/1			116x60x172 h
1470EN-PI	460,00	10 EN			49x60x150 h
1472EN-PI	513,00	12 EN			49x60x172 h
1475EN-PI	628,00	20 EN			89x60x150 h
1477EN-PI	699,00	24 EN			89x60x172 h
1480EN-PI	789,00	30 EN			129x60x150 h
1482EN-PI	886,00	36 EN			129x60x172 h



Art. 1476GN

• GN - EN TRAY TROLLEYS WITH PANELS ON 3 SIDES - TOP SHELF WITH RAILS

Article	€	Tray capacity	Runners	Shelf spacing cm	Max dim. cm
1471GN	592,00	10 GN 1/1	L	11	45x60x150 h
1474GN	657,00	12 GN 1/1			45x60x172 h
1476GN	859,00	20 GN 1/1			80x60x150 h
1478GN	955,00	24 GN 1/1			80x60x172 h
1481GN	1.120,00	30 GN 1/1			116x60x150 h
1483GN	1.254,00	36 GN 1/1			116x60x172 h
1471EN	592,00	10 EN			49x60x150 h
1474EN	657,00	12 EN			49x60x172 h
1476EN	859,00	20 EN			89x60x150 h
1478EN	955,00	24 EN			89x60x172 h
1481EN	1.120,00	30 EN			129x60x150 h
1483EN	1.254,00	36 EN			129x60x172 h

Optional	€	📷	Description	Suitable for
F	22,00	1	Set with 2 braked castors	All articles
E	166,00	2	Set with 4 resilient castors, 2 with brake, for uneven floors / outdoor use	
Accessories	€	📷	Description	Suitable for
A050GN	62,00	3	Removable stainless steel container (1 for each column)	GN models with panels on 2 sides
A050EN	62,00			EN models with panels on 2 sides



GN - EN TRAY TROLLEYS - OAK STAINED PANELS

- AISI 304 stainless steel 2x2 cm square tube construction with bolted cross-members
- Stainless steel sheet "L"-shaped runners suitable for GN or EN trays (depending on the model)
- Oak stained melamine-faced panels
- Grey rubber ring buffers
- Swivel castors, ø 12.5 cm



Art. 1475GN-PN

• GN - EN TRAY TROLLEYS WITH PANELS ON 2 SIDES

Article	€	Tray capacity	Runners	Shelf spacing cm	Max dim. cm
1470GN-PN	426,00	10 GN 1/1	L	11	45x60x150 h
1472GN-PN	473,00	12 GN 1/1			45x60x172 h
1475GN-PN	594,00	20 GN 1/1			80x60x150 h
1477GN-PN	659,00	24 GN 1/1			80x60x172 h
1480GN-PN	754,00	30 GN 1/1			116x60x150 h
1482GN-PN	846,00	36 GN 1/1			116x60x172 h
1470EN-PN	426,00	10 EN			49x60x150 h
1472EN-PN	473,00	12 EN			49x60x172 h
1475EN-PN	594,00	20 EN			89x60x150 h
1477EN-PN	659,00	24 EN			89x60x172 h
1480EN-PN	754,00	30 EN			129x60x150 h
1482EN-PN	846,00	36 EN			129x60x172 h

• GN - EN TRAY TROLLEYS WITH PANELS ON 3 SIDES - TOP SHELF WITH RAILS



Art. 1476SGN-F

Article	€	Tray capacity	Runners	Shelf spacing cm	Max dim. cm
1471SGN	524,00	10 GN 1/1	L	11	45x60x150 h
1474SGN	578,00	12 GN 1/1			45x60x172 h
1476SGN	768,00	20 GN 1/1			80x60x150 h
1478SGN	846,00	24 GN 1/1			80x60x172 h
1481SGN	1.004,00	30 GN 1/1			116x60x150 h
1483SGN	1.115,00	36 GN 1/1			116x60x172 h
1471SEN	524,00	10 EN			49x60x150 h
1474SEN	578,00	12 EN			49x60x172 h
1476SEN	768,00	20 EN			89x60x150 h
1478SEN	846,00	24 EN			89x60x172 h
1481SEN	1.004,00	30 EN			129x60x150 h
1483SEN	1.115,00	36 EN			129x60x172 h

Optional	€	Description	Suitable for
F	22,00	1 Set with 2 braked castors	All articles
E	166,00	2 Set with 4 resilient castors, 2 with brake, for uneven floors / outdoor use	
Accessories	€	Description	Suitable for
A050GN	62,00	3 Removable stainless steel container (1 for each column)	GN models with panels on 2 sides
A050EN	62,00		EN models with panels on 2 sides



GN - EN TRAY TROLLEYS - TOBACCO OAK STAINED PANELS

- AISI 304 stainless steel 2x2 cm square tube construction with bolted cross-members
- Stainless steel sheet "L"-shaped runners suitable for GN or EN trays (depending on the model)
- Tobacco oak stained melamine-faced panels
- Grey rubber ring buffers
- Swivel castors, ø 12.5 cm

Tobacco oak



Art. 1475GN-PNT

• GN - EN TRAY TROLLEYS WITH PANELS ON 2 SIDES

Article	€	Tray capacity	Runners	Shelf spacing cm	Max dim. cm
1470GN-PNT	438,00	10 GN 1/1	L	11	45x60x150 h
1472GN-PNT	488,00	12 GN 1/1			45x60x172 h
1475GN-PNT	606,00	20 GN 1/1			80x60x150 h
1477GN-PNT	674,00	24 GN 1/1			80x60x172 h
1480GN-PNT	767,00	30 GN 1/1			116x60x150 h
1482GN-PNT	860,00	36 GN 1/1			116x60x172 h
1470EN-PNT	438,00	10 EN			49x60x150 h
1472EN-PNT	488,00	12 EN			49x60x172 h
1475EN-PNT	606,00	20 EN			89x60x150 h
1477EN-PNT	674,00	24 EN			89x60x172 h
1480EN-PNT	767,00	30 EN			129x60x150 h
1482EN-PNT	860,00	36 EN			129x60x172 h

• GN - EN TRAY TROLLEYS WITH PANELS ON 3 SIDES - TOP SHELF WITH RAILS



Art. 1476SGNT-F

Article	€	Tray capacity	Runners	Shelf spacing cm	Max dim. cm
1471SGNT	549,00	10 GN 1/1	L	11	45x60x150 h
1474SGNT	605,00	12 GN 1/1			45x60x172 h
1476SGNT	802,00	20 GN 1/1			80x60x150 h
1478SGNT	882,00	24 GN 1/1			80x60x172 h
1481SGNT	1.047,00	30 GN 1/1			116x60x150 h
1483SGNT	1.161,00	36 GN 1/1			116x60x172 h
1471SENT	549,00	10 EN			49x60x150 h
1474SENT	605,00	12 EN			49x60x172 h
1476SENT	802,00	20 EN			89x60x150 h
1478SENT	882,00	24 EN			89x60x172 h
1481SENT	1.047,00	30 EN			129x60x150 h
1483SENT	1.161,00	36 EN			129x60x172 h

Optional	€	📷	Description	Suitable for
F	22,00	1	Set with 2 braked castors	All articles
E	166,00	2	Set with 4 resilient castors, 2 with brake, for uneven floors / outdoor use	
Accessories	€	📷	Description	Suitable for
A050GN	62,00	3	Removable stainless steel container (1 for each column)	GN models with panels on 2 sides
A050EN	62,00			EN models with panels on 2 sides



GN - EN TRAY TROLLEYS - WHITE STAINED PANELS

- AISI 304 stainless steel 2x2 cm square tube construction with bolted cross-members
- Stainless steel sheet "L"-shaped runners suitable for GN or EN trays (depending on the model)
- White stained melamine-faced panels
- Grey rubber ring buffers
- Swivel castors, ø 12.5 cm

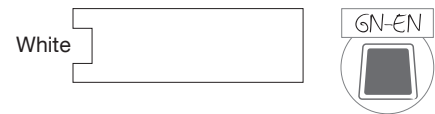

Art. 1470GN-PNB

• GN - EN TRAY TROLLEYS WITH PANELS ON 2 SIDES

Article	€	Tray capacity	Runners	Shelf spacing cm	Max dim. cm
1470GN-PNB	426,00	10 GN 1/1	L	11	45x60x150 h
1472GN-PNB	473,00	12 GN 1/1			45x60x172 h
1475GN-PNB	594,00	20 GN 1/1			80x60x150 h
1477GN-PNB	659,00	24 GN 1/1			80x60x172 h
1480GN-PNB	754,00	30 GN 1/1			116x60x150 h
1482GN-PNB	846,00	36 GN 1/1			116x60x172 h
1470EN-PNB	426,00	10 EN			49x60x150 h
1472EN-PNB	473,00	12 EN			49x60x172 h
1475EN-PNB	594,00	20 EN			89x60x150 h
1477EN-PNB	659,00	24 EN			89x60x172 h
1480EN-PNB	754,00	30 EN			129x60x150 h
1482EN-PNB	846,00	36 EN			129x60x172 h

• GN - EN TRAY TROLLEYS WITH PANELS ON 3 SIDES - TOP SHELF WITH RAILS



Art. 1476SENB-F

Article	€	Tray capacity	Runners	Shelf spacing cm	Max dim. cm
1471SGNB	524,00	10 GN 1/1	L	11	45x60x150 h
1474SGNB	578,00	12 GN 1/1			45x60x172 h
1476SGNB	768,00	20 GN 1/1			80x60x150 h
1478SGNB	846,00	24 GN 1/1			80x60x172 h
1481SGNB	1.004,00	30 GN 1/1			116x60x150 h
1483SGNB	1.115,00	36 GN 1/1			116x60x172 h
1471SENB	524,00	10 EN			49x60x150 h
1474SENB	578,00	12 EN			49x60x172 h
1476SENB	768,00	20 EN			89x60x150 h
1478SENB	846,00	24 EN			89x60x172 h
1481SENB	1.004,00	30 EN			129x60x150 h
1483SENB	1.115,00	36 EN			129x60x172 h

Optional	€	📷	Description	Suitable for
F	22,00	1	Set with 2 braked castors	All articles
E	166,00	2	Set with 4 resilient castors, 2 with brake, for uneven floors / outdoor use	
Accessories				
Accessories	€	📷	Description	Suitable for
A050GN	62,00	3	Removable stainless steel container (1 for each column)	GN models with panels on 2 sides
A050EN	62,00			EN models with panels on 2 sides



GN -EN TRAY TROLLEYS - CUSTOMIZED PANELS ON 2 SIDES

- AISI 304 stainless steel 2x2 cm square tube construction with bolted cross-members
- Stainless steel sheet "L"-shaped runners suitable for GN or EN trays (depending on the model)
- Melamine-faced panels covered with adhesive PVC, with water-proof UV-resistant customizable digital print
- Grey rubber ring buffers
- Swivel castors, ø 12.5 cm





Art. 1470GN-ADV-F + A050GN

customizable

CUSTOMIZABLE WATER-PROOF
UV-RESISTANT DIGITAL PRINT
NOTE: the file containing the
image should be provided by you

Article	€	Tray capacity	Runners	Shelf spacing cm	Max dim. cm
1470GN-ADV	623,00	10 GN 1/1	L	11	45x60x150 h
1472GN-ADV	689,00	12 GN 1/1			45x60x172 h
1475GN-ADV	791,00	20 GN 1/1			80x60x150 h
1477GN-ADV	875,00	24 GN 1/1			80x60x172 h
1480GN-ADV	952,00	30 GN 1/1			116x60x150 h
1482GN-ADV	1.062,00	36 GN 1/1			116x60x172 h
1470EN-ADV	623,00	10 EN			49x60x150 h
1472EN-ADV	689,00	12 EN			49x60x172 h
1475EN-ADV	791,00	20 EN			89x60x150 h
1477EN-ADV	875,00	24 EN			89x60x172 h
1480EN-ADV	952,00	30 EN			129x60x150 h
1482EN-ADV	1.062,00	36 EN			129x60x172 h

Optional	€	📷	Description	Suitable for
F	22,00	1	Set with 2 braked castors	All articles  
E	166,00	2	Set with 4 resilient castors, 2 with brake, for uneven floors / outdoor use	

Accessories	€	📷	Description	Suitable for
A050GN	62,00	3	Stainless steel removable container (1 for each column)	GN models
A050EN	62,00			EN models

UNIVERSAL TRAY TROLLEYS

- AISI 304 stainless steel 2x2 cm square tube construction with bolted cross-members
- Chrome-plated steel wire supports suitable for trays having a maximum dimension of 53x39 cm even in different sizes and shapes
- Grey rubber ring buffers
- Swivel castors, ø 12.5 cm

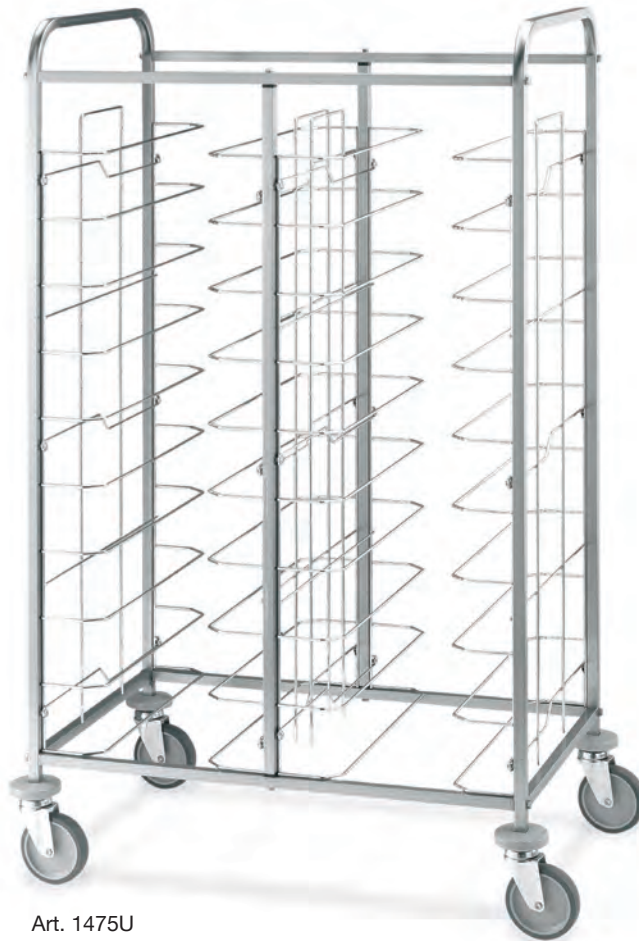

Art. 1475U

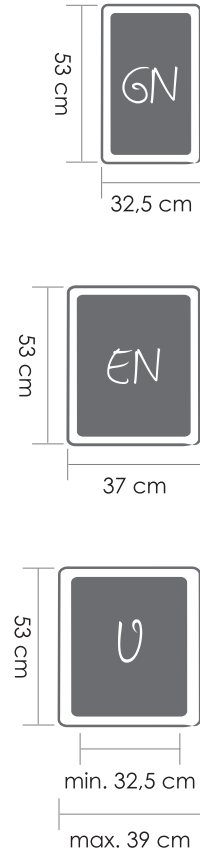

Article	€	Tray capacity	Runners	Shelf spacing cm	Max dim. cm
1470U	320,00	10 U	Wire		52x60x159 h
1472U	343,00	12 U			52x60x183 h
1475U	478,00	20 U			95x60x159 h
1477U	525,00	24 U			95x60x183 h
1480U	634,00	30 U			138x60x159 h
1482U	707,00	36 U			138x60x183 h
Optional	€	Description	Suitable for		
F	22,00	1 Set with 2 braked castors	All articles		
E	166,00	2 Set with 4 resilient castors, 2 with brake, for uneven floors / outdoor use			
Accessories	€	Description	Suitable for		
A050U	73,00	3 Removable stainless steel Universal-size container (1 for each column)	All articles		



UNIVERSAL TRAY TROLLEYS WITH AISI 304 STAINLESS STEEL PANELS

- AISI 304 stainless steel 2x2 cm square tube construction with bolted cross-members
- Chrome-plated steel wire supports suitable for trays having a maximum dimension of 53x39 cm even in different sizes and shapes
- AISI 304 stainless steel panels
- Grey rubber ring buffers
- Swivel castors, ø 12.5 cm

Stainless steel



Art. 1475U-PI

• UNIVERSAL TRAY TROLLEYS WITH PANELS ON 2 SIDES

Article	€	Tray capacity	Runners	Shelf spacing cm	Max dim. cm
1470U-PI	473,00	10 U	Wire		52x60x159 h
1472U-PI	518,00	12 U			52x60x183 h
1475U-PI	632,00	20 U			95x60x159 h
1477U-PI	701,00	24 U			95x60x183 h
1480U-PI	787,00	30 U			138x60x159 h
1482U-PI	882,00	36 U			138x60x183 h



Art. 1476U

• UNIVERSAL TRAY TROLLEYS WITH PANELS ON 3 SIDES - TOP SHELF WITH RAILS

Article	€	Tray capacity	Runners	Shelf spacing cm	Max dim. cm
1471U	614,00	10 U	Wire		52x60x159 h
1474U	672,00	12 U			52x60x183 h
1476U	879,00	20 U			95x60x159 h
1478U	975,00	24 U			95x60x183 h
1481U	1.141,00	30 U			138x60x159 h
1483U	1.277,00	36 U			138x60x183 h

Optional	€	📷	Description	Suitable for
F	22,00	1	Set with 2 braked castors	All articles
E	166,00	2	Set with 4 resilient castors, 2 with brake, for uneven floors / outdoor use	
<hr/>				
Accessories	€	📷	Description	Suitable for
A050U	73,00	3	Removable stainless steel Universal-size container (1 for each column)	All articles with panels on 2 sides



UNIVERSAL TRAY TROLLEYS - OAK STAINED PANELS

- AISI 304 stainless steel 2x2 cm square tube construction with bolted cross-members
- Chrome-plated steel wire supports suitable for trays having a maximum dimension of 53x39 cm even in different sizes and shapes
- Oak stained melamine-faced panels
- Grey rubber ring buffers
- Swivel castors, ø 12.5 cm



Art. 1470U-PN

• UNIVERSAL TRAY TROLLEYS WITH PANELS ON 2 SIDES

Article	€	Tray capacity	Runners	Shelf spacing cm	Max dim. cm
1470U-PN	432,00	10 U	Wire		52x60x159 h
1472U-PN	471,00	12 U			52x60x183 h
1475U-PN	591,00	20 U			95x60x159 h
1477U-PN	654,00	24 U			95x60x183 h
1480U-PN	746,00	30 U			138x60x159 h
1482U-PN	835,00	36 U			138x60x183 h



Art. 1471SU

• UNIVERSAL TRAY TROLLEYS WITH PANELS ON 3 SIDES - TOP SHELF WITH RAILS

Article	€	Tray capacity	Runners	Shelf spacing cm	Max dim. cm
1471SU	538,00	10 U	Wire		52x60x159 h
1474SU	583,00	12 U			52x60x183 h
1476SU	777,00	20 U			95x60x159 h
1478SU	853,00	24 U			95x60x183 h
1481SU	1.014,00	30 U			138x60x159 h
1483SU	1.123,00	36 U			138x60x183 h

Optional	€	📷	Description	Suitable for
F	22,00	1	Set with 2 braked castors	All articles
E	166,00	2	Set with 4 resilient castors, 2 with brake, for uneven floors / outdoor use	
Accessories	€	📷	Description	Suitable for
A050U	73,00	3	Removable stainless steel Universal-size container (1 for each column)	All articles with panels on 2 sides



UNIVERSAL TRAY TROLLEYS - TOBACCO OAK STAINED PANELS

- AISI 304 stainless steel 2x2 cm square tube construction with bolted cross-members
- Chrome-plated steel wire supports suitable for trays having a maximum dimension of 53x39 cm even in different sizes and shapes
- Tobacco oak stained melamine-faced panels
- Grey rubber ring buffers
- Swivel castors, ø 12.5 cm

Tobacco oak



Art. 1470U-PNT-F + A050U

• UNIVERSAL TRAY TROLLEYS WITH PANELS ON 2 SIDES

Article	€	Tray capacity	Runners	Shelf spacing cm	Max dim. cm
1470U-PNT	449,00	10 U	Wire		52x60x159 h
1472U-PNT	490,00	12 U			52x60x183 h
1475U-PNT	607,00	20 U			95x60x159 h
1477U-PNT	672,00	24 U			95x60x183 h
1480U-PNT	763,00	30 U			138x60x159 h
1482U-PNT	854,00	36 U			138x60x183 h



Art. 1476SUT-F

• UNIVERSAL TRAY TROLLEYS WITH PANELS ON 3 SIDES - TOP SHELF WITH RAILS

Article	€	Tray capacity	Runners	Shelf spacing cm	Max dim. cm
1471SUT	571,00	10 U	Wire		52x60x159 h
1474SUT	620,00	12 U			52x60x183 h
1476SUT	823,00	20 U			95x60x159 h
1478SUT	903,00	24 U			95x60x183 h
1481SUT	1.070,00	30 U			138x60x159 h
1483SUT	1.186,00	36 U			138x60x183 h

Optional	€	📷	Description	Suitable for
F	22,00	1	Set with 2 braked castors	All articles
E	166,00	2	Set with 4 resilient castors, 2 with brake, for uneven floors / outdoor use	
Accessories				
Accessories	€	📷	Description	Suitable for
A050U	73,00	3	Removable stainless steel Universal-size container (1 for each column)	All articles with panels on 2 sides



UNIVERSAL TRAY TROLLEYS - WHITE STAINED PANELS

- AISI 304 stainless steel 2x2 cm square tube construction with bolted cross-members
- Chrome-plated steel wire supports suitable for trays having a maximum dimension of 53x39 cm even in different sizes and shapes
- White stained melamine-faced panels
- Grey rubber ring buffers
- Swivel castors, ø 12.5 cm

White

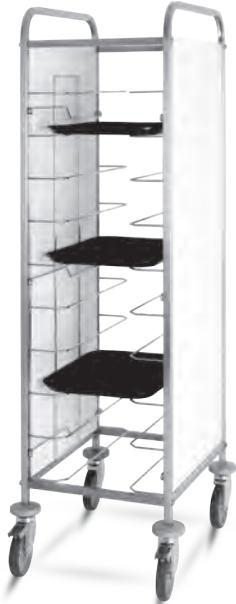

Art. 1470U-PNB-F

• UNIVERSAL TRAY TROLLEYS WITH PANELS ON 2 SIDES

Article	€	Tray capacity	Runners	Shelf spacing cm	Max dim. cm
1470U-PNB	435,00	10 U	Wire		52x60x159 h
1472U-PNB	474,00	12 U			52x60x183 h
1475U-PNB	594,00	20 U			95x60x159 h
1477U-PNB	657,00	24 U			95x60x183 h
1480U-PNB	749,00	30 U			138x60x159 h
1482U-PNB	838,00	36 U			138x60x183 h



Art. 1476SUB-F

• UNIVERSAL TRAY TROLLEYS WITH PANELS ON 3 SIDES - TOP SHELF WITH RAILS

Article	€	Tray capacity	Runners	Shelf spacing cm	Max dim. cm
1471SUB	543,00	10 U	Wire		52x60x159 h
1474SUB	590,00	12 U			52x60x183 h
1476SUB	786,00	20 U			95x60x159 h
1478SUB	863,00	24 U			95x60x183 h
1481SUB	1.024,00	30 U			138x60x159 h
1483SUB	1.134,00	36 U			138x60x183 h

Optional	€	📷	Description	Suitable for
F	22,00	1	Set with 2 braked castors	All articles
E	166,00	2	Set with 4 resilient castors, 2 with brake, for uneven floors / outdoor use	
Accessories	€	📷	Description	Suitable for
A050U	73,00	3	Removable stainless steel Universal-size container (1 for each column)	All articles with panels on 2 sides



UNIVERSAL TRAY TROLLEYS - CUSTOMIZED PANELS ON 2 SIDES

- AISI 304 stainless steel 2x2 cm square tube construction with bolted cross-members
- Chrome-plated steel wire supports suitable for trays having a maximum dimension of 53x39 cm even in different sizes and shapes
- Grey rubber ring buffers
- Swivel castors, ø 12.5 cm

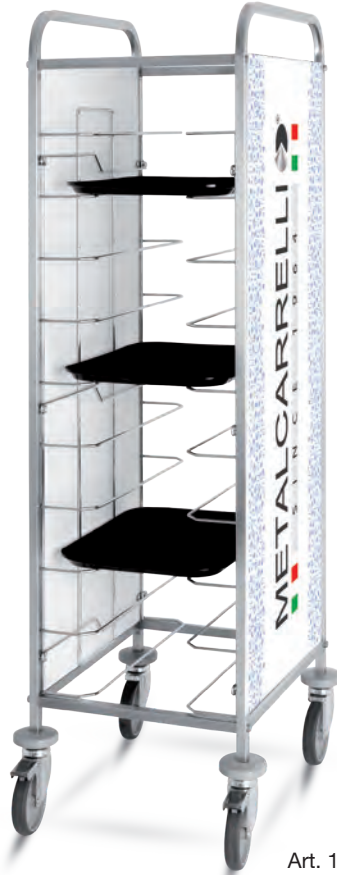

customizable

CUSTOMIZABLE WATER-PROOF
UV-RESISTANT DIGITAL PRINT
NOTE: the file containing the
image should be provided by you

Art. 1470U-ADV-F

Article	€	Tray capacity	Runners	Shelf spacing cm	Max dim. cm
1470U-ADV	633,00	10 U	Wire		52x60x159 h
1472U-ADV	690,00	12 U			52x60x183 h
1475U-ADV	791,00	20 U			95x60x159 h
1477U-ADV	873,00	24 U			95x60x183 h
1480U-ADV	947,00	30 U			138x60x159 h
1482U-ADV	1.055,00	36 U			138x60x183 h

Optional	€	📷	Description	Suitable for
F	22,00	1	Set with 2 braked castors	All articles
E	166,00	2	Set with 4 resilient castors, 2 with brake, for uneven floors / outdoor use	
Accessories	€	📷	Description	Suitable for
A050U	73,00	3	Removable stainless steel Universal-size container (1 for each column)	All articles

GN / EN TRAY TROLLEYS

- AISI 304 stainless steel 2.5x2.5 cm square tube construction with bolted cross-members
- Stainless steel sheet "L"-shaped runners
- Grey rubber ring buffers
- Swivel castors, ø 12.5 cm



SUITABLE FOR GN/EN
AND EUROTHERM TRAYS

eurotherm
trays



GN/EN
trays

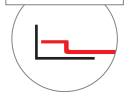

Art. 1494-GN-F

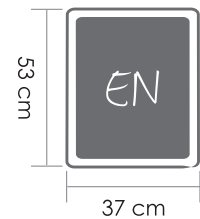
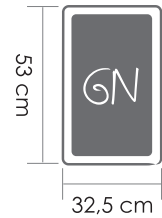

Article	€	Tray capacity	Runners	Shelf spacing cm	Max dim. cm
1494-GN	427,00	12 GN 1/1	L		45x60x190 h
1495-GN	658,00	24 GN 1/1			81x60x190 h
1494-EN	427,00	12 EN			50x60x190 h
1495-EN	658,00	24 EN			90x60x190 h

Optional	€	Image	Description	Suitable for
F	22,00		Set with 2 braked castors	All articles
E	166,00		Set with 4 resilient castors, 2 with brake, for uneven floors / outdoor use	

Accessories	€	Image	Description	Suitable for
A050GN	62,00		Removable stainless steel container (1 for each column)	GN models
A050EN	62,00			EN models

GN CONTAINER TROLLEYS WITH WIRE RUNNERS

- AISI 304 stainless steel 2x2 cm square tube construction with bolted cross-members
- Stainless steel wire supports
- Suitable for GN trays and containers
- Stainless steel top (Art. 2080 - 2082)
- Grey rubber ring buffers (Art. 2090 - 2092)
- Swivel castors - ø 9.5 cm (Art. 2080 - 2082) or ø 12.5 cm (Art. 2090 - 2092)



Art. 2080-F

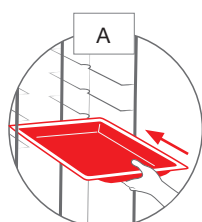

1/1 GN
TRAYS-CONTAINERS
SHORT-SIDE LOADING



Art. 2092

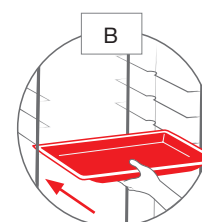

2/1 GN
TRAYS-CONTAINERS
LONG-SIDE LOADING

Article	€	Tray-container capacity	Runners	Shelf spacing cm	Max dim. cm
2080	362,00	9 GN 1/1	Wire		42x59x87 h
2082	396,00	9 GN 2/1			62x69x87 h
2090	536,00	20 GN 1/1			47x63x181 h
2092	571,00	20 GN 2/1			67x73x181 h

Optional	€	📷	Description	Suitable for	📷
F	10,00	1	Set with 2 braked castors	2080 - 2082	1
F	22,00	2		2090 - 2092	2

Accessories	€	📷	Description	Suitable for	📷
A0170	39,00	3	1/1 GN stainless steel wire shelf	2080 - 2090	3
A0171	64,00	4	2/1 GN stainless steel wire shelf	2082 - 2092	4

GN CONTAINER TROLLEYS - "C"- SHAPED RUNNERS

- AISI 304 stainless steel 2x2 cm square tube construction with bolted cross-members
- "C"-shaped stainless steel sheet runners to prevent containers from overturning
- Suitable for GN containers
- Stainless steel top (Art. 2073 - 2074 - 2073D)
- Grey rubber ring buffers
- Swivel castors \varnothing cm 9.5 (Art. 2073 - 2074 - 2073D) or \varnothing cm 12.5 (Art. 2070 - 2071 - 2072)



Art. 2071



Art. 2072-F



Art. 2073D

Article	€	Container capacity	Runners	Shelf spacing cm	Max dim. cm
2073	350,00	8 GN 1/1		 7.5	44x60x85 h
2074	386,00	8 GN 2/1			65x72x85 h
2073D	565,00	8+8 GN 1/1			80x60x89 h
2070	406,00	14 GN 1/1		8.5	44x60x163 h
2071	479,00	18 GN 1/1		7.5	44x60x176 h
2072	464,00	14 GN 2/1		8.5	65x72x163 h

Optional	€		Description	Suitable for
F	10,00	2	Set with 2 braked castors	2073 - 2074 - 2073D
F	22,00	1		2070 - 2071 - 2072
 1 2				
Accessories	€		Description	Suitable for
A0170	39,00	3	1/1 GN stainless steel wire shelf	2070 - 2071 - 2073 - 2073D
A0171	64,00	4	2/1 GN stainless steel wire shelf	2072 - 2074
 3				
 4				

GN CONTAINER TROLLEYS - "C"- SHAPED RUNNERS



- AISI 304 stainless steel 2x2 cm square tube construction with bolted cross-members
- "C"-shaped stainless steel sheet runners with end stops to prevent containers from sliding and overturning
- Suitable for GN containers
- "S" version with welded structure, crosspieces and flaps
- Grey rubber ring buffers
- Swivel castors, ø 12.5 cm





Art. 2062-F



Art. 2060-F

Article	€	Container capacity	Runners	Shelf spacing cm		Max dim. cm
2060	615,00	18 GN 2/1			Unassembled	65x73x180 h
2060S	696,00				Welded	
2062	561,00	18 GN 1/1			Unassembled	45x61x180 h
2062S	634,00				Welded	

Optional	€		Description	Suitable for	
F	22,00	1	Set with 2 braked castors	All articles	1

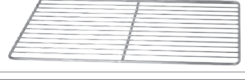
Accessories	€		Description	Suitable for	
A0170	39,00	2	1/1 GN stainless steel wire shelf	2062 - 2062S	2
A0171	64,00	3	2/1 GN stainless steel wire shelf	2060 - 2060S	3

TROLLEYS FOR CONTAINERS 60x40 cm - "L"- SHAPED RUNNERS

- AISI 304 stainless steel 2x2 cm square tube construction with bolted cross-members
- Stainless steel "L"-shaped runners
- Suitable for 60x40 cm containers
- Stainless steel top (Art. 2078)
- Grey rubber ring buffers
- Swivel castors - ø 9.5 cm (Art. 2078)
or ø 12.5 cm (Art. 2076 - 2077)

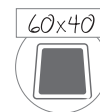



Art. 2078



Art. 2076-F

Article	€	Container capacity	Runners	Shelf spacing cm	Max dim. cm
2078	361,00	8	L	7.5	52x72x85 h
2076	434,00	14		8.5	52x72x163 h
2077	479,00	18		7.5	52x72x176 h



Optional	€	Image	Description	Suitable for	Image
F	10,00	1	Set with 2 braked castors	2078	 1
F	22,00	2		2076 - 2077	 2



TROLLEYS FOR CONTAINERS 60x40 cm - "L" - SHAPED RUNNERS

- AISI 304 stainless steel 2.5x2.5 cm square tube construction with bolted cross-members
- Stainless steel "L"-shaped runners with end stops
- Suitable for 60x40 cm containers
- "S" version with welded structure, crosspieces and flaps
- Grey rubber ring buffers
- Swivel castors, ø 12.5 cm



Art. 2066-F

Article	€	Container capacity	Runners	Shelf spacing cm		Max dim. cm
2066	578,00	18			Unassembled	53x68x172 h
2066S	658,00				Welded	

Optional	€		Description	All articles	
F	22,00	1	Set with 2 braked castors	All articles	1

TROLLEYS FOR CONTAINERS 60x40 cm

- Stainless steel 3.5x3.5 cm square tube construction with bolted cross-members
- Stainless steel tubular supports - ø 1.6 cm
- Suitable for 60x40 cm containers
- Swivel castors, ø 12.5 cm

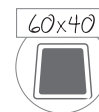

Art. 1497

Article	€	Container capacity	Runners	Shelf spacing cm	Max dim. cm
1497	420,00	20	Tube	7.3	57x55x158 h

Optional	€	Icon	Description
F	22,00	1	Set with 2 braked castors





NEUTRAL TRAY/PAN MOBILE CUPBOARDS

- AISI 304 stainless steel sheet construction, brushed finish
- 1 front hinged door opening to 270° with magnet (to keep the door open)
- Snap closure handle
- 2 Stainless steel tubular pushing bars with PVC brackets on one side
- "C"-shaped or "L"-shaped stainless steel sheet supports for trays/containers of various shapes and sizes
- All round grey non marking rubber bumper
- Swivel castors - ø 12.5 cm, 2 with brake

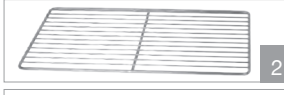

Art. 3342GN

Article	€	Tray/container capacity	Runners	Shelf spacing cm	Max dim. cm
3342GN	935,00	10 GN 1/1	L	11	52x65x142 h
3342EN	952,00	10 EN			56x65x142 h
3343	1.031,00	15 GN 1/1	C	7.5	52x65x142 h
3345	1.225,00	15 GN 2/1			72x77x142 h
3344	1.143,00	18 - 60x40 cm	L	6.5	59x77x145 h



Optional	€	Description	Suitable for
E	80,00	Set with 4 resilient castors, 2 with brake, for uneven floors / outdoor use	All articles 
Accessories	€	Description	Suitable for
A0170	39,00	1/1GN stainless steel wire rack	3343 
A0171	64,00	2/1GN stainless steel wire rack	3345 

HEATED INSULATED PAN MOBILE CUPBOARDS

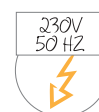
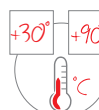
- AISI 304 stainless steel insulated structure, brushed finish
- 270° opening front door with magnet (to keep the door open)
- Removable door gasket
- Handle with snap closure, optional with lock
- Pushing handle
- Inside compartment made with round corners in compliance with H1 hygiene standard, suitable for GN containers
- Ventilated heating unit powered with fan and heating element
- Control panel with ON/OFF switch with operation warning light and digital thermostat, coiled power cord on the backside
- Mains supply: 230V - 50 Hz (60 Hz upon request), single-phased
- Water container to release moisture inside the cupboard
- All round grey non marking rubber bumper
- Swivel castors, ø cm 12.5, 2 with brake



Art. 3421-10GS

Article	€	GN	Runners	Shelf spacing cm	Power	Max dim. cm
3411-10GS	2.977,00	10 GN 1/1	 	5.5	1600W	55x80x110 h
3421-10GS	3.281,00	10 GN 2/1				72x92x110 h
3411-20GS	3.570,00	20 GN 1/1				55x80x166 h
3421-20GS	3.937,00	20 GN 2/1				72x92x166 h



Pressed runners
made with one single
sheet layer for easy cleaning

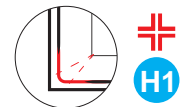

**Compartment with
no-sharp edges**
compliant with "H1"
hygiene system



270° opening door
To easily fit GN containers

Art. 3411-20GS



Optional	€	Description	Suitable for
E	80,00	Set with 4 resilient castors, 2 with brake for uneven floors / outdoor use	All articles
MA	107,00	Door handle with lock	
Accessories	€	Description	Suitable for
A0170	39,00	1/1GN stainless steel wire rack	3411-10GS / 3411-20GS
A0171	64,00	2/1GN stainless steel wire rack	3421-10GS / 3421-20GS

HEATED INSULATED PAN MOBILE CUPBOARD

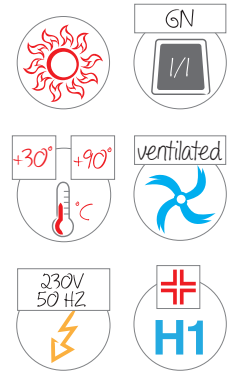
- AISI 304 stainless steel insulated structure, brushed finish
- 270° opening front door with magnet (to keep the door open)
- Removable door gasket
- Handle with snap closure, optional with lock
- Pushing handle
- 180° opening lid, when open it acts as a support surface
- Side drop-down shelf for GN 1/1 containers
- Inside compartment made with round corners in compliance with H1 hygiene standard, suitable for GN 1/1 containers
- Ventilated heating unit powered with fan and heating element
- Control panel with ON/OFF switch with operation warning light and digital thermostat, coiled power cord on the backside
- Mains supply: 230V - 50 Hz (60 Hz upon request), single-phased
- All round grey non marking rubber bumper
- Swivel castors, ø cm 12.5, 2 with brake



Art. 3411-11GS

Article	€	GN	Runners	Shelf spacing cm	Power	Max dim. cm	
3411-11GS	3.850,00	11 GN 1/1			5.5	900W	85x59x117 h



Pressed runners
made with one single
sheet layer for easy cleaning

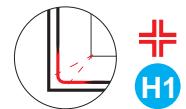

**Compartment with
no-sharp edges**
compliant with "H1"
hygiene system



270° opening door
To easily fit GN containers



Optional	€	Description	Suitable for
E	80,00	Set with 4 resilient castors, 2 with brake for uneven floors / outdoor use	3411-11GS
MA	107,00	Door handle with lock	
Accessories	€	Description	Suitable for
A0170	39,00	1/1GN stainless steel wire rack	3411-11GS

REFRIGERATED INSULATED PAN MOBILE CUPBOARD

- AISI 304 stainless steel insulated structure, brushed finish
- 270° opening front door with magnet (to keep the door open)
- Handle with snap closure, optional with lock
- Pushing handles
- Inside compartment equipped with 16 pressed runners suitable for 1/1 GN containers made with round corners in compliance with H1 hygiene standard
- Ventilated refrigeration +2°C +10°C
- Automatic defrosting and evaporation
- Control panel with ON/OFF switch with operation warning light and digital thermostat, coiled power cord on the backside
- Mains supply: 230V - 50Hz, 60Hz upon request
- All round grey non marking rubber bumper
- Swivel castors, ø cm 12.5, 2 with brake

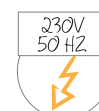
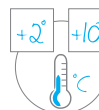

Art. 3415-16GS

Article	€	Tray/pan capacity	Runners	Shelf spacing cm	Power	Max diim. cm
3415-16GS	4.990,00	16 x 1/1 GN		5.5	330W	55,5x79,5x165 h



Pressed runners
made with one single
sheet layer for easy cleaning



**Compartment with
no-sharp edges**
compliant with "H1"
hygiene system



270° opening door
To easily fit GN containers

Art. 3415-16GS

Optional	€	Description
E	80,00	4 resilient castors, ø cm 12.5, 2 with brake, for uneven floors/outdoor use
MA	107,00	Closure handle with lock
Accessories	€	Description
A0170	39,00	Stainless steel wire rack 1/1 GN

NEUTRAL/INSULATED TRAY/PAN MOBILE CUPBOARDS - SINGLE DOOR

- Fully welded AISI 304 stainless steel sheet construction, brushed finish; single or double skin insulated with expanded polyurethane panels fitted between the steel sheet walls ("DP" range)
- Suitable for transport on trucks
- 1 Double skin front door with rubber seal, opening to 270°
- Snap closure handle (optional with lock)
- 2 Pushing bars on both sides that can be used even with open doors
- Internal compartment fitted with runners for pans and trays of different sizes depending on the model
- Thermometer in the double skin version
- All round grey non marking rubber bumper
- 2 Fixed and 2 braked swivel castors, ø 16 cm, with galvanized brackets; grey non marking rubber tread rolling on bearings



Article	€	Tray/pan capacity	Runners	Shelf spacing cm	Max dim. cm
3208GN	2.220,00	8 GN 1/1	L	12	78x73x151 h
3208EN	2.183,00	8 EN		8	
3213GN	2.285,00	13 GN 1/1	C	8	
3208U	2.084,00	8 U	Universal	12	
3212GN	2.410,00	12 GN 1/1	L	12	78x73x191 h
3212EN	2.355,00	12 EN		8	
3218 GN	2.487,00	18 GN 1/1	C	8	
3212U	2.168,00	12 U	Universal	12	
3208GN-DP	2.619,00	8 GN 1/1	L	12	78x73x151 h
3208EN-DP	2.581,00	8 EN		8	
3213GN-DP	2.682,00	13 GN 1/1	C	8	
3208U-DP	2.482,00	8 U	Universal	12	
3212GN-DP	2.875,00	12 GN 1/1	L	12	78x73x191 h
3212EN-DP	2.820,00	12 EN		8	
3218GN-DP	2.952,00	18 GN 1/1	C	8	
3212U-DP	2.633,00	12 U	Universal	12	

NEUTRAL/INSULATED TRAY/PAN MOBILE CUPBOARDS - SINGLE DOOR

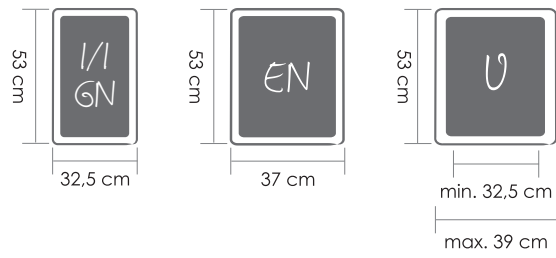

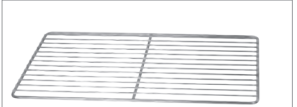
Optional	€	📷	Description	Suitable for
E	80,00	1	Set with 4 resilient castors, 2 with brake for uneven floors / outdoor use	All articles 
MA	107,00	-	Door handle with lock	
Accessories	€	📷	Description	Suitable for
A0170	39,00	2	1/1 GN stainless steel wire rack	GN models 

HEATED TRAY/PAN MOBILE CUPBOARDS - SINGLE DOOR

- Fully welded AISI 304 stainless steel sheet construction, brushed finish; double skin insulated with expanded polyurethane panels fitted between the steel sheet walls
- Suitable for transport on trucks
- 1 Double skin front door with rubber seal opening to 270°
- Snap closure handle (optional with lock)
- 2 Pushing bars on both sides that can be used even with open doors
- Internal compartment fitted with runners for containers, pans and trays of different sizes depending on the model
- Analog thermometer
- Ventilated heating unit consisting of an AISI 304 stainless steel sheet casing containing a powered fan and heating element, built-in control panel fitted with ON/OFF switch with warning light, thermostat, operation warning light and coiled power cable on the backside
- The heating unit can be pulled out for an easy maintenance (the cupboard can be washed with a water jet after removing the heating unit)
- Mains supply: 230V, 50 Hz (60 Hz upon request), single-phase
- Water container to release moisture inside the cupboard
- All round grey non marking rubber bumper
- 2 Fixed and 2 braked swivel castors, ø 16 cm, with galvanized brackets; grey non marking rubber tread rolling on bearings



Article	€	Tray/pan capacity	Runners	Shelf spacing cm	Power	Max dim. cm
3208GN-K	3.233,00	8 GN 1/1	L	12	1600W	78x73x151 h
3208EN-K	3.196,00	8 EN		78x73x151 h		
3213GN-K	3.297,00	13 GN 1/1	C	8		78x73x151 h
3208U-K	3.134,00	8 U	Universal	12		78x73x151 h
3212GN-K	3.491,00	12 GN 1/1	L	12		78x73x191 h
3212EN-K	3.435,00	12 EN				
3218GN-K	3.567,00	18 GN 1/1	C	8		
3212U-K	3.248,00	12 U	Universal	12		

HEATED TRAY/PAN MOBILE CUPBOARDS - SINGLE DOOR

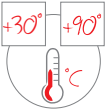
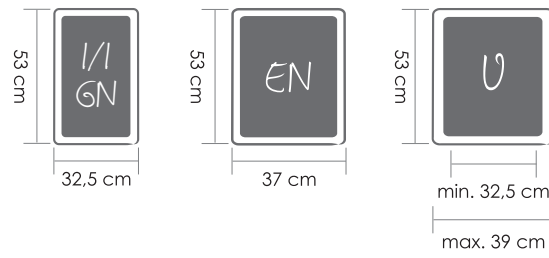

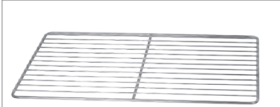
Optional	€	📷	Description	Suitable for
E	80,00	1	Set with 4 resilient castors, 2 with brake for uneven floors / outdoor use	 1 All articles
MA	107,00	-	Door handle with lock	
Accessories	€	📷	Description	Suitable for
A0170	39,00	2	1/1 GN stainless steel wire rack	GN models  2

NEUTRAL/INSULATED TRAY/PAN MOBILE CUPBOARDS - DOUBLE DOOR

- Fully welded AISI 304 stainless steel sheet construction, brushed finish; single skin, or double skin insulated with expanded polyurethane panels fitted between the steel sheet walls ("DP" range)
- Suitable for transport on trucks
- 2 Double skin front doors with rubber seal, opening to 270°
- Snap closure handles (optional with lock)
- 2 Pushing bars on both sides that can be used even with open doors
- Internal compartment fitted with runners for containers pans and trays of different sizes depending on the model
- Thermometer in the double skin version
- All round grey non marking rubber bumper
- 2 Fixed and 2 braked swivel castors, ø 16 cm, with galvanized brackets; grey non marking rubber tread rolling on bearings



Article	€	Tray/pan capacity	Runners	Shelf spacing cm	Max dim. cm
3216GN	3.231,00	8x2 GN 1/1	L	12	131x73x151 h
3216EN	3.156,00	8x2 EN		8	
3226GN	3.359,00	13x2 GN 1/1	Universal	12	
3216U	2.956,00	8x2 U		12	
3224GN	3.674,00	12x2 GN 1/1	L	12	131x73x191 h
3224EN	3.561,00	12x2 EN		8	
3236GN	3.826,00	18x2 GN 1/1	Universal	12	
3224U	3.189,00	12x2 U		12	
3216GN-DP	3.421,00	8x2 GN 1/1	L		131x73x151 h
3216EN-DP	3.347,00	8x2 EN			
3226GN-DP	4.057,00	13x2 GN 1/1	Universal	12	
3216U-DP	3.146,00	8x2 U		12	
3224GN-DP	4.431,00	12x2 GN 1/1	L	12	131x73x191 h
3224EN-DP	4.319,00	12x2 EN		8	
3236GN-DP	4.584,00	18x2 GN 1/1	Universal	12	
3224U-DP	3.946,00	12x2 U		12	

NEUTRAL/INSULATED TRAY/PAN MOBILE CUPBOARDS - DOUBLE DOOR

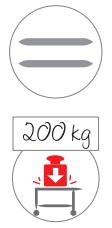
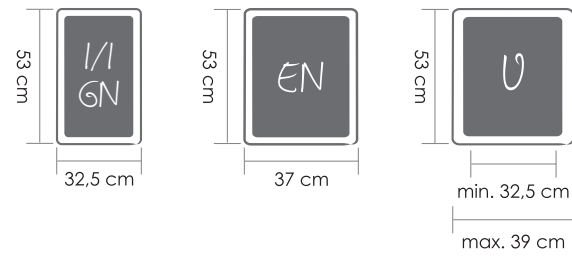

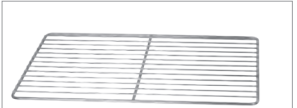
Optional	€	📷	Description	Suitable for
E	80,00	1	Set with 4 resilient castors, 2 with brake for uneven floors / outdoor use	All articles 
MA	107,00	-	Door handle with lock	
Accessories	€	📷	Description	Suitable for
A0170	39,00	2	1/1 GN stainless steel wire rack	GN models 

HEATED TRAY/PAN MOBILE CUPBOARDS - DOUBLE DOOR

- Fully welded AISI 304 stainless steel sheet construction, brushed finish; double skin insulated with expanded polyurethane panels fitted between the steel sheet walls
- Suitable for transport on trucks
- 2 Double skin front doors with rubber seal opening to 270°
- Snap closure handles (optional with lock)
- 2 Pushing bars on both sides that can be used even with open doors
- Internal compartment fitted with runners for containers, pans and trays of different sizes depending on the model
- Analog thermometer
- Ventilated heating unit consisting of an AISI 304 stainless steel sheet casing containing a powered fan and heating element, built-in control panel fitted with ON/OFF switch with warning light, thermostat, operation warning light and coiled power cable on the back
- The heating unit can be pulled out for ease of maintenance (the cupboard can be washed with a water jet after removing the heating unit)
- Mains supply: 230V, 50 Hz (60 Hz upon request), single-phase
- Water container to release moisture inside the cupboard
- All round grey non marking rubber bumper
- 2 Fixed and 2 braked swivel castors, ø 16 cm, with galvanized brackets; grey non marking rubber tread rolling on bearings



Article	€	Tray/pan capacity	Runners	Shelf spacing cm	Power	Max dim. cm
3216GN-K	4.609,00	8x2 GN 1/1	L	12	3200W	131x73x151 h
3216EN-K	4.533,00	8x2 EN		8		
3226GN-K	5.244,00	13x2 GN 1/1	Universal	12		
3216U-K	4.335,00	8x2 U	L	12		
3224GN-K	5.620,00	12x2 GN 1/1				12
3224EN-K	5.507,00	12x2 EN	C	8		
3236GN-K	5.771,00	18x2 GN 1/1				Universal
3224U-K	5.134,00	12x2 U				

HEATED TRAY/PAN MOBILE CUPBOARDS - DOUBLE DOOR

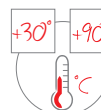
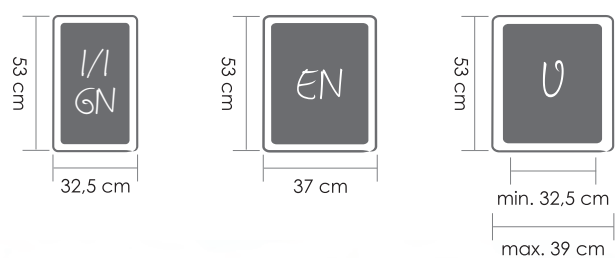

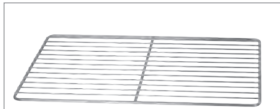
Optional	€	📷	Description	Suitable for
E	80,00	1	Set with 4 resilient castors, 2 with brake for uneven floors / outdoor use	All articles  1
MA	107,00	-	Door handle with lock	
Accessories	€	📷	Description	Suitable for
A0170	39,00	2	1/1 GN stainless steel wire rack	GN models  2

NEUTRAL/INSULATED TRAY/PAN MOBILE CUPBOARDS - SINGLE DOOR

- Fully welded AISI 304 stainless steel sheet construction, brushed finish; single or double skin insulated with expanded polyurethane panels fitted between the steel sheet walls ("DP" range)
- Suitable for transport on trucks
- 1 Double skin front door opening to 270° with rubber seal
- Snap closure handle (optional with lock)
- 2 Pushing bars on both sides that can be used even with open doors
- Internal compartment fitted with runners for containers, pans and trays of different shapes depending on the model
- Thermometer in the double skin version
- All round grey non marking rubber bumper
- 2 Fixed and 2 braked swivel castors, ø 16 cm, with galvanized brackets; grey non marking rubber tread rolling on bearings



Article	€	Tray/pan capacity	Runners	Shelf spacing cm	Max dim. cm
3213-6040	2.513,00	13 - 60x40 cm	L		93x88x151 h
3213-2GN	2.527,00	13 GN 2/1	C		
3218-6040	2.758,00	18 - 60x40 cm	L		
3218-2GN	2.772,00	18 GN 2/1	C		
3213-6040-DP	2.950,00	13 - 60x40 cm	L		
3213-2GN-DP	2.964,00	13 GN 2/1	C		
3218-6040-DP	3.286,00	18 - 60x40 cm	L		
3218-2GN-DP	3.301,00	18 GN 2/1	C		

NEUTRAL/INSULATED TRAY/PAN MOBILE CUPBOARDS - SINGLE DOOR

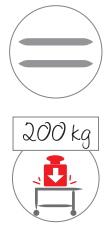
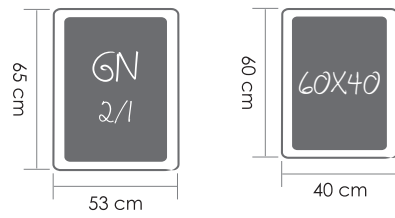

Optional	€	📷	Description	Suitable for
E	80,00	1	Set with 4 resilient castors, 2 with brake for uneven floors / outdoor use	All articles
MA	107,00	-	Door handle with lock	
Accessories	€	📷	Description	Suitable for
A0171	64,00	2	2/1GN stainless steel wire rack	GN models

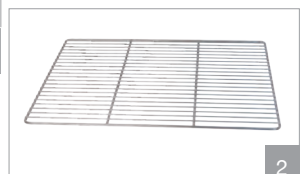

HEATED TRAY/PAN MOBILE CUPBOARDS - SINGLE DOOR

- Fully welded AISI 304 stainless steel sheet construction, brushed finish; double skin insulated with expanded polyurethane panels fitted between the steel sheet walls
- Suitable for transport on trucks
- 1 Double skin front door opening to 270° with rubber seal
- Snap closure handles (optional with lock)
- 2 Pushing bars on both sides that can be used even with open doors
- Internal compartment fitted with runners for containers, pans and trays of different sizes depending on model
- Analog thermometer
- Ventilated heating unit consisting of an AISI 304 stainless steel sheet casing containing a powered fan and heating element, built-in control panel fitted with ON/OFF switch with warning light, thermostat, operation warning light and coiled power cable on the back
- The heating unit can be pulled out for ease of maintenance (the cupboard can be washed with a water jet after removing the heating unit)
- Mains supply: 230V, 50 Hz (60 Hz upon request), single-phase
- Water container to release moisture inside the cupboard
- All round grey non marking rubber bumper
- 2 Fixed and 2 braked swivel castors, ø 16cm, with galvanized brackets; grey non marking rubber tread rolling on bearings



Article	€	Tray/pan capacity	Runners	Shelf spacing cm	Power	Max dim. cm
3213-6040-K	3.556,00	13 - 60x40 cm	L		1600W	93x88x151 h
3213-2GN-K	3.569,00	13 GN 2/1	C			
3218-6040-K	3.893,00	18 - 60x40 cm	L			
3218-2GN-K	3.906,00	18 GN 2/1	C			93x88x191 h

HEATED TRAY/PAN MOBILE CUPBOARDS - SINGLE DOOR

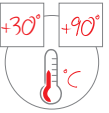
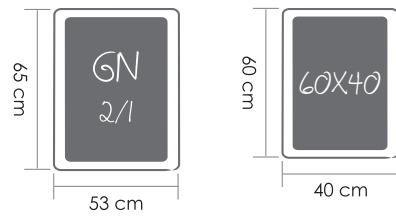

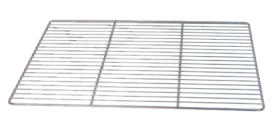
Optional	€	📷	Description	Suitable for
E	80,00	1	Set with 4 resilient castors, 2 with brake for uneven floors / outdoor use	 All articles
MA	107,00	-	Door handle with lock	
Accessories	€	📷	Description	Suitable for
A0171	64,00	2	2/1GN stainless steel wire rack	 GN models





Reception trolleys
Room service tables
Housekeeping trolleys



BIRDCAGE LUGGAGE CARTS _____ 188



LUGGAGE CARTS WITH GARMENT RAIL _____ 192



LUGGAGE HANDTRUCK AND PLATFORM CARTS _____ 194



LUGGAGE RACKS _____ 196



ROOM SERVICE TABLES _____ 198



STAINLESS STEEL FOOD WARMERS AND TROLLEY FOR FOOD WARMERS _____ 200



MINIBAR RESTOCKING TROLLEYS _____ 202



BASIC CHAMBERMAID TROLLEYS _____ 204



HOUSEKEEPING CUPBOARD TROLLEYS _____ 210



LINEN TRUCKS _____ 212



BRASS-PLATED BIRDCAGE LUGGAGE CARTS

- Brass-plated steel tube frame protected by clear coat
- Deck with red or black carpet (depending on the model) with full wrap-around rubber bumper
- 2 Fixed and 2 braked swivel castors, ø 16 cm

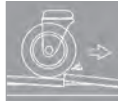

Art. 1950R-E

Article	€	Carpet colour	Max dim. cm
1921N	1.049,00	Black	79x59x189 h
1921R	1.049,00	Red	
1920N	1.091,00	Black	99x59x189 h
1920R	1.091,00	Red	
1950N	1.268,00	Black	108x76x189 h
1950R	1.268,00	Red	

Optional	€	📷	Description	Suitable for		
E	166,00	1	Set of 4 resilient castors, 2 with brake for uneven floors / outdoor use	All articles		1



CHROME-PLATED BIRDCAGE LUGGAGE CARTS

- Chrome-plated steel tube frame
- Deck with red or black carpet (depending on the model)
- Full wrap-around rubber bumper
- 2 Fixed and 2 braked swivel castors, ø 16 cm



Art. 1950CN

Article	€	Carpet colour	Max dim. cm
1922CN	876,00	Black	79x59x189 h
1922CR	876,00	Red	
1920CN	908,00	Black	99x59x189 h
1920CR	908,00	Red	
1950CN	1.073,00	Black	108x76x189 h
1950CR	1.073,00	Red	

Optional	€		Description	Suitable for	
E	166,00	1	Set of 4 resilient castors, 2 with brake for uneven floors / outdoor use	All articles	1



AISI 304 STAINLESS STEEL BIRDCAGE LUGGAGE CARTS

- AISI 304 stainless steel tube frame with polished or brushed finish (depending on the model)
- Deck with red or black carpet (depending on the model)
- Full wrap-around rubber bumper
- 2 Fixed and 2 braked swivel castors, ø 16 cm



Art. 1922XR

Article	€	Finish	Carpet colour	Max dim. cm
1922XR	1.279,00	Polished	Red	79x59x189 h
1922XN	1.279,00		Black	
1922SR	1.191,00	Brushed	Red	
1922SN	1.191,00		Black	
1920XR	1.326,00	Polished	Red	99x59x189 h
1920XN	1.326,00		Black	
1920SR	1.239,00	Brushed	Red	
1920SN	1.239,00		Black	
1950XR	1.448,00	Polished	Red	108x76x189 h
1950XN	1.448,00		Black	
1950SR	1.362,00	Brushed	Red	
1950SN	1.362,00		Black	

Optional	€	Description	Suitable for
E	166,00	1  Set of 4 resilient castors, 2 with brake for uneven floors / outdoor use	All articles 



Art. 1950XN



Art. 1920XN

LUGGAGE CART WITH GARMENT RAIL

- AISI 304 stainless steel tube garment rail structure
- AISI 304 stainless steel sheet deck
- Side pushing bars
- Grey rubber bumper rings at corners
- Swivel castors, ø 12.5 cm



Art. 1795

Article	€		Max dim. cm
1795	460,00		115x58x156 h

Optional	€		Description	
F	40,00	1	Set with 2 braked castors	1

- Easily demountable chrome or brass plated steel frame (depending on the model)
- 150 cm-long garment rail with side extension bars, 40 cm each (total cm 240)
- Swivel castors ø cm 8



Extensible bar



Art. 1796



Art. 1796D

- Chrome-plated metal garment rail with hat rack (hangers not included)
- Demountable structure
- 150 cm-long garment rail
- Swivel castors ø 4.5 cm



Art. 1797

Article	€	Description	Max dim. cm
1796	97,00	Chrome-plated	150x55x153 h (with retracted extension bars)
1796D	227,00	Brass-plated	
1797	223,00	Chrome-plated metal	150x55x172 h

LUGGAGE HANDTRUCK

- Steel zinc-coated tube frame, protected by clear coat
- 2 front rubber ring buffers
- Stackable
- 2 Fixed castors (ø 20 cm) and 2 swivel castors (ø 12.5 cm)



Art. 1488

Article	€	Max dim. cm
1488	436,00	102x60x97 h

LUGGAGE PLATFORM CARTS

- Aluminium painted steel sheet tube frame
- Carpeted deck
- Lateral retaining bars (depending on the model)
- Ring bumpers
- 2 Fixed and 2 swivel castors, ø 16 cm



Art. 1894.1



Art. 1894.2



Art. 1894.3

Article	€	Description	Max dim. cm
1894.1	548,00	Without retaining bars	144x66x95 h
1894.2	599,00	With retaining bars on 1 side	
1894.3	653,00	With retaining bars on 2 sides	
Optional	€	Description	Suitable for
F	40,00	1 Set with 2 braked castors	All articles
E	80,00	2 Set of 4 resilient castors, 2 with brake, for uneven floors/outdoor use	

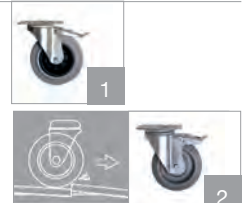

LUGGAGE RACKS

- Folding wooden structure
- With or without back guard (depending on the model)

- Cotton cloth



Art. 1463S



Art. 1462

- Leather straps



Art. 1464



Art. 1465

- Black PVC straps



Art. 1460



Art. 1461S

- Chrome or brass-plated tubular steel frame
- With or without back guard (depending on the model)
- Rubber feet
- Black PVC straps



Art. 1755P



Art. 1751P

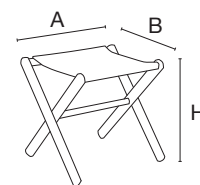

Article	€	Finish	Back guard	Material	Max dim. cm (AxBxH)
1460	70,00	Dark walnut	Yes	Black PVC straps	49x43x53
1460S	69,00		-	Black PVC straps	49x38x48
1461	70,00	Natural wood	Yes	Black PVC straps	49x43x53
1461S	69,00		-	Black PVC straps	49x38x48
1462	69,00	Natural wood	Yes	Cotton cloth	49x44x51
1462S	67,00		-	Cotton cloth	49x40x46
1463	69,00	Dark walnut	Yes	Cotton cloth	49x44x51
1463S	67,00		-	Cotton cloth	49x40x46
1464	161,00	Natural wood	-	Leather straps	50x50x55
1465	166,00	Dark walnut	-	Leather straps	50x50x55
1750P	75,00	Chrome-plated	Yes	Black PVC straps	56x40x62
1755P	62,00		-	Black PVC straps	56x33x41
1751P	81,00	Brass-plated	Yes	Black PVC straps	56x40x62
1756P	77,00		-	Black PVC straps	56x33x41

ROOM SERVICE TABLES

- Stainless steel construction, brushed finish
- Round water-repellent black MDF top protected by transparent coating, folding side leaves
- The top folds vertically to nest the tables together and save space
- Swivel castors, ø 9.5 cm, 2 with brake

Black



Art. 1104-80N



Foldable - Nestable



Folding side leaves for easy transport in narrow spaces

Article	€	Top shelf dim. cm	Max dim. cm
1104-80N	424,00	ø 80	ø 80x78 h
1104-90N	488,00	ø 90	ø 90x78 h
1104-100N	529,00	ø 100	ø 100x78 h

Article	€	📷	Description	Suitable for
A0001	419,00	1	Stainless steel food warmer	1104-100N
A0003	419,00			1104-80N - 1104-90N



- Stainless steel construction, brushed finish
- Square water-repellent black MDF top protected by transparent coating, folding side leaves
- The top folds vertically to nest the tables together and save space
- Swivel castors, ø 9.5 cm, 2 with brake

Black 



Art. 1104-Q80N



Foldable - Nestable

Article	€	Top shelf dim. cm	Max dim. cm
1104-Q80N	424,00	80x80	80x80x78 h
1104-Q90N	488,00	90x90	90x90x78 h
1104-Q100N	529,00	100x100	100x100x78 h

Article	€		Description	Suitable for
A0001	419,00	1	Stainless steel food warmer	1104-Q100N
A0003	419,00			1104-Q80N - 1104-Q90N



STAINLESS STEEL FOOD WARMERS

- Stainless steel sheet construction, polished finish
- Suitable for plates with a max ø 32 cm
- PVC handle to transport the food warmer
- Front hinged door, opening to 180°
- Lockable opening handle with snap closure
- Intermediate perforated shelf
- Static heating
- ON/OFF switch with warning light
- Adjustable thermostat
- Removable power cable
- Mains supply: 230V, 50/60 Hz, single-phase

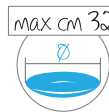
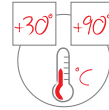

Art. A0003



Article	€	Suitable for	Power	Max dim. cm
A0001	419,00	1104-100N / 1104-Q100N	400W	39x46x51 h
A0003	419,00	1104-80N / 1104-90N / 1104-Q80N / 1104-Q90N		45x46x51 h

TROLLEY FOR STAINLESS STEEL FOOD WARMERS

- AISI 304 stainless steel tube construction with stainless steel sheet shelves
- Max capacity: 6 insulated food warmers (Art. A0001 - A0003)
- Max absorbed power: 2400W
- Mains supply: 230V, 50/60 Hz, single-phase
- Grey rubber ring buffers
- Swivel castors, ø 12.5 cm, 2 with brake



Art. 1150 + A0003 (x6)



Article	€	Power	Max dim. cm
1150	741,00	6 x 400W	153x56x139 h

MINIBAR RESTOCKING TROLLEYS

- AISI 304 tainless steel 2x2 cm square tube frame
- 3 Removable PVC racks fitted with inserts to prevent tipping for no. 40 bottles – max ø 6.5 cm
- Grey rubber ring buffers
- Swivel castors, ø 12.5 cm



Art. 2050-F

Article	€		Max dim. cm
2050	420,00		73x47x102 h
Optional	€		Description
F	22,00	1	Set with 2 braked castors 

MINIBAR RESTOCKING CUPBOARD TROLLEY

- Grey epoxy powder painted steel sheet construction with 1 base and 3 intermediate height-adjustable shelves
- Removable PVC bin for empty bottles
- Side pushing handle
- 180° opening doors with lock
- All round grey non marking rubber bumper
- 2 Fixed and 2 swivel castors, ø 16 cm



Art. 2012-F



Art. 2012-F

Article	€		Max dim. cm
2012	877,00		100x62x119 h
Optional	€	📷	Description
F	40,00	1	Set with 2 braked castors
E	80,00	2	Set of 4 resilient castors, 2 with brake for uneven floors/outdoor use



BASIC CHAMBERMAID TROLLEYS – STAINLESS STEEL/PLASTIC COATED WOOD EFFECT FINISH

- Stainless steel ø 2.5 cm tube construction
- Steel sheet plastic coated shelves, wood effect finish
- No sharp edges
- Pressed aluminium corner joints to fix the shelves to the frame with rounded inner angles
- 1 or 2 folding bag holders with canvas bag for dirty linen (depending on the model)
- Grey rubber ring buffers
- Swivel castors, ø 12.5 cm

Walnut

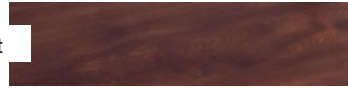

Detail of folded bag holder



Art. 4402

Article	€	Shelves	Shelf dim. cm	Description	Max dim. cm (open)	Max dim. cm (folded)
4402	433,00	3	70x45	1 folding bag holder with canvas bag for dirty linen	114x52x106 h	87x52x121 h
4404	581,00	4		2 folding bag holders with canvas bags for dirty linen	140x52x130 h	87x52x145 h

Optional	€	📷	Description	Suitable for
F	22,00	1	Set with 2 braked castors	All articles
E	166,00	2	Set of 4 resilient castors, 2 with brake, for uneven floors/outdoor use	



1



2

BASIC CHAMBERMAID TROLLEYS – STAINLESS STEEL/PLASTIC COATED WOOD EFFECT FINISH



Art. 4404

Accessories	€		Description	Suitable for	
R0040	39,00	3	Canvas bag for dirty linen	4402	
R0010	49,00			4404	

3

BASIC CHAMBERMAID TROLLEYS WITH MELAMINE-FACED SHELVES

- Stainless steel 2x2 cm square tube frame
- Melamine-faced shelves
- Folding bag holder with canvas bag for dirty linen
- Grey rubber bumpers
- Swivel castors, ø 12.5 cm



Art. 4410T-F



Art. 4415-F

Article	€	Shelves	Description	Finish	Max dim. cm (open)	Max dim. cm (folded)
4410	490,00	4	1 folding bag holder with canvas bag for dirty linen	Oak	140x52x137 h	101x52x151 h
4410T	529,00			Tobacco oak		
4415	655,00	4	1 folding bag holder with canvas bag for dirty linen + 1 folding waste bag holder with lid and partition panel	Oak	140x52x137 h	101x52x151 h
4415T	707,00			Tobacco oak		
Optional	€		Description	Suitable for		
F	22,00	1	Set with 2 braked castors	All articles		
E	166,00	2	Set of 4 resilient castors, 2 with brake, for uneven floors/outdoor use			
Accessories	€	Description		Suitable for		
R0010	49,00	Canvas bag for dirty linen		All articles		

BASIC CHAMBERMAID TROLLEYS WITH MELAMINE-FACED SHELVES

- Stainless steel 2x2 cm square tube frame
- Melamine-faced shelves
- 2 folding bag holders with canvas bags for dirty linen
- Grey rubber ring buffers
- Swivel castors, ø 12.5 cm



Art. 4430.90-F

Article	€	Shelves	Shelf dim. cm	Description	Finish	Max dim. cm (open)	Max dim. cm (folded)
4430.70	469,00	4	70x45	2 folding bag holders with canvas bag for dirty linen	Oak	120x52x137 h	81x52x151 h
4430.70T	507,00				Tobacco oak		
4430.90	506,00	4	90x45	2 folding bag holders with canvas bag for dirty linen	Oak	140x52x137 h	101x52x151 h
4430.90T	548,00				Tobacco oak		
Optional	€		Description		Suitable for		
F	22,00	1	Set with 2 braked castors		All articles	1	
E	166,00	2	Set of 4 resilient castors, 2 with brake, for uneven floors/outdoor use			2	
Accessories	€	Description		Suitable for			
R0010	49,00	Canvas bag for dirty linen		All articles			

EQUIPABLE HOUSEKEEPING TROLLEYS WITH MELAMINE-FACED SHELVES

- Stainless steel 2x2 cm square tube frame
- Melamine-faced shelves and side panels
- Folding bag holder with canvas bag for dirty linen
- All round grey non marking rubber bumper
- Swivel castors, ø cm 12.5



Article	€	Finish	Description	Max dim. cm (open)	Max dim. cm (folded)
4450	563,00	Oak	73 cm Base	102x52x134 h	73x52x151 h
4450T	608,00	Tobacco oak			
4451	602,00	Oak	73 cm Base + side panels		
4451T	653,00	Tobacco oak			
4452	635,00	Oak	73 cm Base + panels on 3 sides		
4452T	685,00	Tobacco oak			
4470	579,00	Oak	93 cm Base	119x52x134 h	93x52x151 h
4470T	625,00	Tobacco oak			
4471	630,00	Oak	93 cm Base + side panels		
4471T	681,00	Tobacco oak			
4472	676,00	Oak	93 cm Base + panels on 3 sides		
4472T	729,00	Tobacco oak			
4490	611,00	Oak	113 cm Base	139x52x134 h	113x52x151 h
4490T	659,00	Tobacco oak			
4491	661,00	Oak	113 cm Base + side panels		
4491T	713,00	Tobacco oak			
4492	719,00	Oak	113 cm Base + panels on 3 sides		
4492T	776,00	Tobacco oak			

EQUIPABLE HOUSEKEEPING TROLLEYS WITH MELAMINE-FACED SHELVES



Top loading compartmental tray for amenities with lid and lock

or

Top loading compartmental tray for amenities



Art. A43

Folding waste bag holder with lid, partition panel and small bag support shelf

or

Art. A41

Folding bag holder ring with canvas bag for dirty linen



Optional	€		Description	Suitable for
F	40,00	1	Set with 2 braked castors	Tutti
E	80,00	2	Set of 4 resilient castors, 2 with brake, for uneven floors/outdoor use	
Accessories	€		Description	Suitable for
A41	80,00		Folding bag holder with canvas bag for dirty linen	All articles
A43	124,00		Folding waste bag holder with lid and small bag support shelf	
A44-70	105,00		Top loading compartmental tray, 60 cm	with 93 cm base
A45-70	226,00		Top loading compartmental tray with lid and lock, 60 cm	
A44-90	120,00		Top loading compartmental tray, 80 cm	with 113 cm base
A45-90	246,00		Top loading compartmental tray with lid and lock, 80 cm	
R0015	71,00		Canvas bag for dirty linen	All articles



EQUIPABLE HOUSEKEEPING CUPBOARD TROLLEYS

- Steel sheet structure with grey epoxy powder coating
- Folding bag holder with canvas bag (depending on the model)
- Waste bag holder with lid (depending on the model)
- All round grey non marking rubber bumper
- 2 Fixed and 2 swivel castors, ø 16 cm



Art. 2020-F





Art. 2022-F



Art. 2026S-F



Art. 2024S-F





Article	€	Canvas bag	Set for waste bag	Doors	Max dim. cm (open)	Max dim. cm (folded)
2020	671,00	-	-	-	100x62x118 h	100x62x145 h
2022	747,00	1	-		130x62x118 h	
2026	901,00	1	1		160x62x118 h	
2024	822,00	2	-		160x62x118 h	
2020S	846,00	-	-	2	100x62x118 h	
2022S	921,00	1	-		130x62x118 h	
2026S	1.076,00	1	1		160x62x118 h	
2024S	996,00	2	-		160x62x118 h	
Optional	€		Description	Suitable for		
F	40,00	1	Set with 2 braked castors	All articles	 1	
E	80,00	2	Set of 4 resilient castors, 2 with brake, for uneven floors/outdoor use		 2	



Art. A45-90
Top loading compartmental tray for amenities with lid and lock, 80 cm



Art. 2026S-F + A45-90

Accessories	€		Description	Suitable for	
A45-90	246,00	3	Top loading compartmental tray with lid&lock	All articles	 3
A44-90	120,00	4	Open top loading compartmental tray		 4
R0015	71,00	5	Canvas bag for dirty linen		 5

LINEN TRUCKS

- White plastic-coated steel tube foldable structure (Art. 1500)
- White painted steel tube and wire foldable structure (Art. 1505-1510)
- Swivel wheels - various diameters available (depending on the model)

INDOOR USE
AND FLAT FLOORS ONLY



Art. 1505 folded



Art. 1500 folded



Art. 1500 + R0020



Art. 1505



Art. 1510

Article	€	Wheel ø cm	Max dim. cm	
1500	117,00	8	80x51x75 h	
1505	246,00	9.5	80x52x77 h	
1510	261,00		100x60x87 h	
Accessories	€	Description	Suitable for	
R0020	74,00	1	Canvas bag for dirty linen	1500 - 1505
R0030	78,00			1510



POLYPROPYLENE LINEN TRUCKS

- Structure made of polypropylene snap-in tubes
- Wheels mounted onto a galvanized steel frame (various diameters available depending on the model)



Art. 15502



Art. 15508



Art. 15504



Art. 15506



Art. 15500

Article	€	Wheel ø cm	Max dim. cm	Packaging
15500	877,00	12.5	134x75x84 h	NOTE: PACKAGING WITH TRANSPARENT FILM
15502	637,00	10	102x63x82 h	
15504	562,00		95x63x66 h	
15506	361,00	8	83x48x62 h	
15508	422,00		83x48x79 h	





Platform trucks
Roll-containers
Hand washers / Changing room lockers
Storage shelving systems



PLATFORM TRUCKS _____ 216



ROLL CONTAINERS _____ 220



HAND WASHERS _____ 226



HAND TRUCK _____ 228



PAPER TOWEL DISPENSERS _____ 229



CHANGING ROOM LOCKERS _____ 230



STORAGE SHELVING SYSTEMS _____ 232

STAINLESS STEEL PLATFORM TRUCKS

- AISI 304 stainless steel sheet platform
- 1 or 2 stainless steel tube handles (depending on the model)
- 2 Fixed and 2 swivel castors, ø 12.5 cm, grey non marking rubber tread on centre with roller bearing hub



Art. 1895



Art. 1897-F

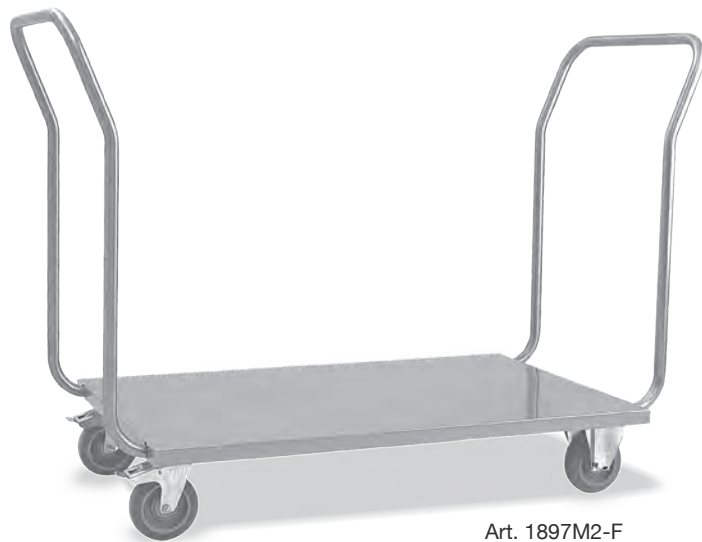

Art. 1897M2-F

Article	€	Description	Platform dimension cm	Max dim. cm
1895	239,00	1 pushing handle	60x60	60x70x97 h
1896	305,00		60x80	60x90x97 h
1897	338,00		60x100	60x110x97 h
1895M2	282,00	2 pushing handles	60x60	60x80x97 h
1896M2	353,00		60x80	60x100x97 h
1897M2	387,00		60x100	60x120x97 h
Optional	€	Description	Suitable for	
F	40,00	1 Set with 2 braked castors	All articles	



EXTENSIBLE PLATFORM TRUCKS

- Stainless steel 2.5x2.5 cm square tube structure
- Grey rubber bumpers at the corners
- Castors, ø cm 12.5, 2 fixed and 2 swivel with brake, grey non marking rubber tread on centre with roller bearing hub



Art. 1899

Article	€	Max. dim. open with extended platform cm	Max. dim. unextended platform cm	Max. dim. closed cm
1899	706,00	159x60x88 h	110x60x88 h	110x60x26 h

POLYETHYLENE PLATFORM TRUCKS

- Polyethylene base
- Fixed or folding handle in stainless steel tube (depending on the model)
- 2 Fixed and 2 swivel castors, ø 12.5 cm, grey non marking rubber tread on centre with roller bearing hub



NOTE: SUITABLE FOR OUTDOOR USE



Art. 1840



Art. 1841



Art. 1842



Art. 1841 folded

Article	€	Pushing handle	Description	Max dim. cm
1842	217,00	-	No pushing handle	92x57x27 h
1840	252,00	1	Stainless steel rigid round tube handle ø 2.5 cm	107x57x97 h
1841	276,00		Stainless steel folding square tube handle 2.5x2.5 cm	95x57x87 h
1840M2	293,00	2	Stainless steel rigid round tube handles ø 2.5 cm	107x57x97 h
Optional	€		Description	Suitable for
F	40,00	1	Set with 2 braked castors	All articles 

MESH PLATFORM TRUCK

- Bright zinc electroplated steel mesh platform
- Polypropylene swivel castors, ø 10.6 cm

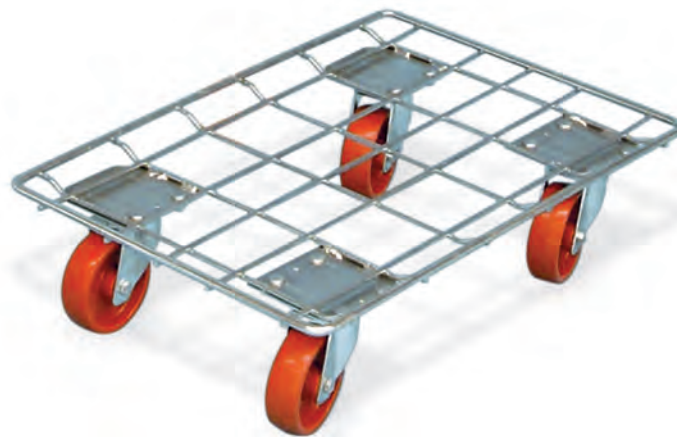

Art. 1836

Article	€	Max dim. cm	Packaging
1836	78,00	62x41x16 h	NOTE: PACKAGING WITH TRANSPARENT FILM

ROLL CONTAINERS

- Roll container composed of 1 wheeled platform and 2 or 3 fixed side frames (depending on the model)
- Welded AISI 304 stainless steel construction
- Removable central shelf (depending on the model)
- 2 fixed and 2 braked swivel castors with heavy-duty brackets, ø 16 cm, grey non marking rubber tread on centre with roller bearing hub



Removable shelf Art. 1831



Art. 1830-EINOX



Art. 1831-EINOX

Article	€	Description	Max dim. cm	Packaging
1830	1.021,00	1 Platform + 2 side frames	94x65x173 h	NOTE: PACKAGING WITH TRANSPARENT FILM
1831	1.208,00	1 Base + 2 side frames + 1 central shelf		
1832	1.098,00	1 Platform + 3 side frames	145x65x198 h	
1833	1.297,00	1 Platform + 3 side frames + 1 central shelf		

Optional	€	Description	Suitable for
E	40,00	Set with 4 resilient castors, 2 with brake	All articles
EINOX	325,00	Set with 4 stainless steel resilient castors, 2 with brake	





Art. 1832



Art. 1833



ROLL CONTAINERS

- Roll container composed of a wheeled platform, 2 side frames and 2 straps
- Bright zinc electroplated tubular frame and reinforcing bars
- Polypropylene castors, \varnothing 10.6 cm - 2 swivel (red) and 2 fixed (black)



Art. 1812



Art. 1812 + A18122 + A18123

Article	€	Description	Max dim. cm	Packaging
1812	153,00	1 Platform + 2 side frames + 2 straps	72x81x180 h	NOTE: PACKAGING WITH TRANSPARENT FILM
Accessories	€	Description		
A18121	6,00	Additional nylon strap		
A18122	58,00	Rear wall		
A18123	79,00	Front opening 2/3		
A18124	30,00	Shelf (max. 3 shelves)		

- Roll container composed of a wheeled platform, 2 side frames and 1 strap
- Bright zinc electroplated tubular frame and reinforcing bars
- Polypropylene castors, ø 10.6 cm - 2 swivel (red) and 2 fixed (black)



Art. 1826 + A18263



Art. 1826 + A18263 + A18264

Article	€	Description	Max dim. cm	Packaging
1826	213,00	1 Platform + 2 side frames + 1 strap	120x81x180 h	NOTE: PACKAGING WITH TRANSPARENT FILM
Accessories	€	Description		
A18262	5,00	Additional nylon strap		
A18263	77,00	Rear wall		
A18264	97,00	Front opening 2/3		
A18261	61,00	Shelf (max. 3 shelves)		

ANTI-THEFT ROLL CONTAINERS

- Safety anti-theft roll container composed of a wheeled platform, 4 side frames (4th side opening to 270°) and closing lid
- PATENTED square tube frame (mesh cm 50x50) fixed to the base by screws and nuts, representing an inviolable rigid and safe structure
- The front doors can be locked by seals or padlocks
- Polypropylene castors, ø 10.6 cm - 2 swivel (red) and 2 fixed (black)



Art. 1815



Article	€	Description	Max dim. cm	Packaging
1815	409,00	1 Platform + 4 sides and closing lid	70x80x180 h	NOTE: PACKAGING WITH TRANSPARENT FILM

Accessories	€	Description	
A18124	30,00	1 Standard intermediate shelf	



ANTI-THEFT ROLL CONTAINERS

- Safety anti-theft roll container composed of a wheeled platform, 4 side frames (the 4th side consists of two 270° opening doors) and closing lid
- PATENTED square tube frame (mesh cm 50x50) fixed to the base by screws and nuts, representing an inviolable rigid and safe structure
- The front doors can be locked by seals or padlocks
- Polypropylene castors, ø 10.6 cm - 2 swivel (red) and 2 fixed (black)



Art. 1827

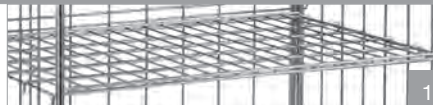

Article	€	Description	Max dim. cm	Packaging
1827	618,00	1 Platform + 2 side frames and closing lid	120x80x180 h	NOTE: PACKAGING WITH TRANSPARENT FILM
Accessories	€	📷 Description		
A18261	59,00	1 Standard intermediate shelf		 1
A18271	63,00	2 Intermediate shelf with edge		 2

HAND WASHERS

- AISI 304 stainless steel hand washers
- Tap and drain included



Art. 9480-4040



Art. 9482-4836

semicircular



Art. 9483-4836

semicircular

Article	€	Description	Max dim. cm
9480-4040	271,00	Wall mounted hand washer with 3 cm-high raised edge with "knee" control	40x40x27 h
9482-4836	378,00	Wall mounted semicircular hand washer with 30 cm-high raised edge with "knee" control	48x36x52 h
9483-4836	328,00	Wall mounted hand washer with 4 cm-high raised edge with "knee" control	48x35x26 h
9484-4040	363,00	Free-standing hand washer with "knee" control	40x40x80 h
9484-5040	372,00		50x40x80 h
9484-5050	404,00		50x50x80 h
9487-4040	539,00	Hand washer on cabinet, with 10 cm-high raised edge, hinged door and siphon included	40x40x95 h
9487-5040	558,00		50x40x95 h
9487-5050	596,00		50x50x95 h



Art. 9484-5040



Art. 9487-5040

HAND TRUCK

- Tubular frame and base in epoxy powder coated steel sheet, red colour
- Pneumatic wheels, ø 26 cm



Art. 1891

Article	€	Max dim. cm
1891	146,00	53x44x105 h



- Stainless steel wall-mounted vertical paper towel dispenser with internal unwinding, satin finish



Art. 2604

- Stainless steel wall-mounted horizontal paper towel dispenser, satin finish





Art. 2608

- Stainless steel wall-mounted paper towel roll holder



Art. 2603

Article	€	Description	Max dim. cm	Kg		 cm	Kg
2604	149,00	Vertical paper towel dispenser	ø 25x32 h	3	M	28x28x40 h	4
2608	172,00	Horizontal paper towel dispenser	ø 30x33 h				4
2603	91,00	Paper towel roll holder	38x17x26 h	1		41x20x29 h	2

CHANGING ROOM LOCKERS

- AISI 430 stainless steel sheet changing room locker
- Sloping roof
- Clothes hook
- Internal partition and shelves
- Lockable doors
- Shoe and hat racks
- Adjustable feet



Art. 9440



Art. 9442



Art. 9444

Article	€	Description	Max dim. cm
9440	664,00	Single locker	50x40x215 h
9442	1.014,00	2-Door locker	95x40x215 h
9444	1.214,00	4-Door locker	

- AISI 430 stainless steel sheet broom locker
- Sloping roof
- Internal partial partition, 3 adjustable shelves
- Lockable doors
- Adjustable feet



Art. 9460



Art. 9462

Article	€	Description	Max dim. cm
9460	725,00	1-Door locker	50x40x215 h
9462	1.040,00	2-Door locker	95x40x215 h

MODULAR SHELVING SYSTEMS

- AISI 304 stainless steel round posts, \varnothing 4 cm, with notches every 10 cm for easy shelf placement
- Stainless steel sheet solid or perforated shelves with plastic angle supports and safety edges to eliminate sharpness
- Adjustable level feet
- Normal shelves: 100 kg/m load capacity
- Reinforced shelves: 150 kg/m load capacity
- Shelves for continuous run systems: 100 kg/m load capacity
- Hooks for continuous runs of shelving and "L"-shaped shelving units



NOTE: CUSTOM MADE SHELF DIMENSIONS UPON REQUEST



Solid shelf



Perforated shelf

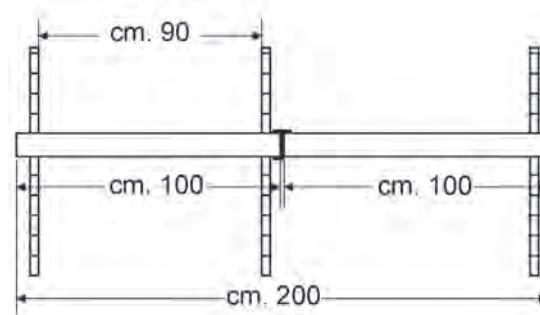
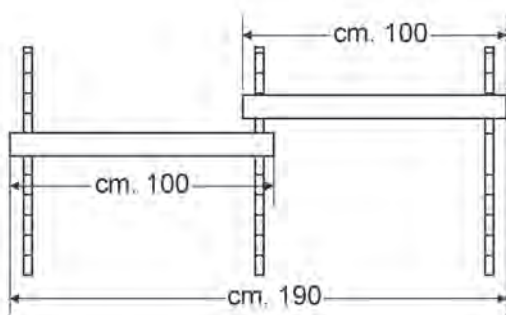

MODULAR SHELVING SYSTEMS

SOLID shelves - Capacity 100 kg/m		
Article	€	Max dim. cm
PLI3080	52,00	80x30
PLI3090	56,00	90x30
PLI30100	60,00	100x30
PLI30110	63,00	110x30
PLI30120	67,00	120x30
PLI4080	58,00	80x40
PLI4090	63,00	90x40
PLI40100	68,00	100x40
PLI40110	72,00	110x40
PLI40120	77,00	120x40
PLI5080	66,00	80x50
PLI5090	71,00	90x50
PLI50100	75,00	100x50
PLI50110	81,00	110x50
PLI50120	87,00	120x50
PLI6080	72,00	80x60
PLI6090	78,00	90x60
PLI60100	83,00	100x60

PERFORATED shelves - Capacity 100 kg/m		
Article	€	Max dim. cm
PAI3080	54,00	80x30
PAI3090	57,00	90x30
PAI30100	61,00	100x30
PAI30110	66,00	110x30
PAI30120	69,00	120x30
PAI4080	60,00	80x40
PAI4090	66,00	90x40
PAI40100	71,00	100x40
PAI40110	75,00	110x40
PAI40120	80,00	120x40
PAI5080	69,00	80x50
PAI5090	74,00	90x50
PAI50100	79,00	100x50
PAI50110	86,00	110x50
PAI50120	91,00	120x50
PAI6080	76,00	80x60
PAI6090	82,00	90x60
PAI60100	89,00	100x60

Round posts, ø 3 cm - Adjustable feet		
Article	€	Max dim. cm
MT150	36,00	150
MT180	41,00	180
MT200	46,00	200

Accessories		
Article	€	Description
PAG001	5,00	Hooks

Reinforced SOLID shelves - Cap. 150 kg/m		
Article	€	Max dim. cm
PLIR30100	83,00	100x30
PLIR30110	89,00	110x30
PLIR30120	93,00	120x30
PLIR30130	98,00	130x30
PLIR30140	102,00	140x30
PLIR40100	92,00	100x40
PLIR40110	97,00	110x40
PLIR40120	103,00	120x40
PLIR40130	109,00	130x40
PLIR40140	113,00	140x40
PLIR50100	99,00	100x50
PLIR50110	107,00	110x50
PLIR50120	113,00	120x50
PLIR50130	119,00	130x50
PLIR50140	124,00	140x50
PLIR60100	108,00	100x60
PLIR60110	115,00	110x60
PLIR60120	122,00	120x60
PLIR60130	130,00	130x60
PLIR60140	136,00	140x60

Reinforced PERFORATED shelves - Cap. 150 kg/m		
Article	€	Max dim. cm
PAIR30100	86,00	100x30
PAIR30110	91,00	110x30
PAIR30120	96,00	120x30
PAIR30130	100,00	130x30
PAIR30140	107,00	140x30
PAIR40100	95,00	100x40
PAIR40110	100,00	110x40
PAIR40120	107,00	120x40
PAIR40130	113,00	130x40
PAIR40140	120,00	140x40
PAIR50100	103,00	100x50
PAIR50110	111,00	110x50
PAIR50120	117,00	120x50
PAIR50130	123,00	130x50
PAIR50140	131,00	140x50
PAIR60100	112,00	100x60
PAIR60110	120,00	110x60
PAIR60120	128,00	120x60
PAIR60130	135,00	130x60
PAIR60140	142,00	140x60

MODULAR SHELVING SYSTEMS

- AISI 304 stainless steel sheet "L"- shaped posts, 3.5x3.5 cm
- Solid or perforated shelves in stainless steel sheet with safety edges to eliminate sharpness
- Stainless steel bolts included
- Optional adjustable feet
- Normal shelves: 100 kg/m load capacity
- Reinforced shelves: 150 kg/m load capacity

100 kg



150 kg



NOTE: CUSTOM MADE SHELF DIMENSIONS UPON REQUEST



MODULAR SHELVING SYSTEMS

SOLID shelves - Capacity 100 kg/m		
Article	€	Max dim. cm
PLB3080	42,00	80x30
PLB3090	47,00	90x30
PLB30100	51,00	100x30
PLB30110	54,00	110x30
PLB30120	57,00	120x30
PLB4080	49,00	80x40
PLB4090	54,00	90x40
PLB40100	59,00	100x40
PLB40110	62,00	110x40
PLB40120	68,00	120x40
PLB5080	56,00	80x50
PLB5090	61,00	90x50
PLB50100	66,00	100x50
PLB50110	72,00	110x50
PLB50120	77,00	120x50
PLB6080	62,00	80x60
PLB6090	69,00	90x60
PLB60100	74,00	100x60
PLB60110	80,00	110x60
PLB60120	87,00	120x60

PERFORATED shelves - Capacity 100 kg/m		
Article	€	Max dim. cm
PAB3080	45,00	80x30
PAB3090	48,00	90x30
PAB30100	52,00	100x30
PAB30110	56,00	110x30
PAB30120	59,00	120x30
PAB4080	51,00	80x40
PAB4090	56,00	90x40
PAB40100	61,00	100x40
PAB40110	66,00	110x40
PAB40120	71,00	120x40
PAB5080	59,00	80x50
PAB5090	65,00	90x50
PAB50100	70,00	100x50
PAB50110	76,00	110x50
PAB50120	81,00	120x50
PAB6080	67,00	80x60
PAB6090	73,00	90x60
PAB60100	79,00	100x60
PAB60110	86,00	110x60
PAB60120	91,00	120x60

"L"-shaped posts 3.5x3.5 cm		
Article	€	Max dim. cm
MA100	21,00	100
MA130	25,00	130
MA150	26,00	150
MA180	31,00	180
MA200	33,00	200

Accessories		
Article	€	Description
PR001	11,00	Adjustable support foot

Reinforced SOLID shelves - Cap. 150 kg/m		
Article	€	Max dim. cm
PLBR30100	74,00	100x30
PLBR30110	80,00	110x30
PLBR30120	84,00	120x30
PLBR30130	89,00	130x30
PLBR30140	94,00	140x30
PLBR40100	82,00	100x40
PLBR40110	89,00	110x40
PLBR40120	95,00	120x40
PLBR40130	99,00	130x40
PLBR40140	104,00	140x40
PLBR50100	90,00	100x50
PLBR50110	98,00	110x50
PLBR50120	104,00	120x50
PLBR50130	110,00	130x50
PLBR50140	116,00	140x50
PLBR60100	98,00	100x60
PLBR60110	105,00	110x60
PLBR60120	114,00	120x60
PLBR60130	120,00	130x60
PLBR60140	128,00	140x60

Reinforced PERFORATED shelves - Cap. 150 kg/m		
Article	€	Max dim. cm
PABR30100	76,00	100x30
PABR30110	80,00	110x30
PABR30120	84,00	120x30
PABR30130	91,00	130x30
PABR30140	97,00	140x30
PABR40100	86,00	100x40
PABR40110	91,00	110x40
PABR40120	96,00	120x40
PABR40130	103,00	130x40
PABR40140	111,00	140x40
PABR50100	94,00	100x50
PABR50110	100,00	110x50
PABR50120	104,00	120x50
PABR50130	114,00	130x50
PABR50140	121,00	140x50
PABR60100	102,00	100x60
PABR60110	109,00	110x60
PABR60120	115,00	120x60
PABR60130	125,00	130x60
PABR60140	134,00	140x60





Trolley wells, Waste bins, Fast-food rubbish bins
Ashtray top paper bins, Waste paper bins, Umbrella stands



WHEELED WASTE COLLECTORS AND TROLLEY WELLS_____ 238



STAINLESS STEEL WASTE BINS_____ 240



FREE-STANDING WASTE SACK-HOLDERS_____ 242



FAST-FOOD RUBBISH BINS_____ 243



RECYCLING BINS_____ 244



SMALL METAL WASTE BINS_____ 247



STAINLESS STEEL PAPER BINS_____ 248



ASHTRAY TOP PAPER BINS_____ 250



UMBRELLA STANDS_____ 251

AISI 304 STAINLESS STEEL WHEELED WASTE COLLECTORS

- AISI 304 stainless steel waste container, brushed finish
- Watertight pressed bottom with no sharp edges
- Manual opening lid: 1/2+1/2
- Wheel-mounted

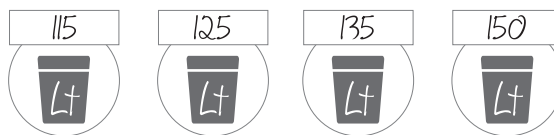

Watertight
pressed bottom



Art. 2101TR



Article	€	Capacity Lt	Max dim. cm
2100TR	441,00	115	40x61x73 h
2101TR	441,00	125	40x61x79 h
2102TR	462,00	135	40x70x73 h
2103TR	462,00	150	40x70x79 h

AISI 304 STAINLESS STEEL TROLLEY WELLS

- AISI 304 stainless steel trolley well with tap, brushed finish
- Watertight pressed bottom with no sharp edges
- Wheel-mounted

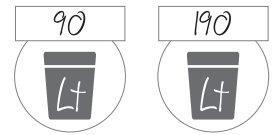

Tap detail

Watertight
pressed bottom



Art. 2112VC

Article	€	Well depth H cm	Capacity Lt	Max dim. cm
2112VC	326,00	30	90	60x50x60 h
2113VC	594,00	44	190	80x60x75 h

AISI 304 STAINLESS STEEL WASTE BINS

- AISI 304 stainless steel waste bin, brushed finish
- Watertight radial pressed bottom with no sharp edges
- Manual or pedal operated opening (depending on the model)
- Wheel-mounted

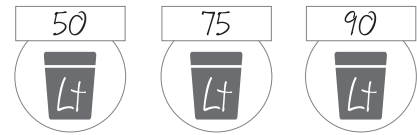

Watertight
pressed bottom



Art. 2175PM



Art. 2190PP



Hanging lid



Pedal operated opening

Article	€	Opening	Capacity Lt	Max dim. cm
2150PM	158,00	Manual	50	ø 39x61 h
2175PM	174,00		75	ø 45x61 h
2190PM	185,00		90	ø 45x69 h
2150PP	212,00	Pedal operated	50	ø 39x61 h
2175PP	234,00		75	ø 45x61 h
2190PP	244,00		90	ø 45x69 h

AISI 304 STAINLESS STEEL WASTE BINS

- AISI 304 stainless steel waste bin, satin finish
- Watertight bottom
- Manual or pedal operated opening (depending on the model)
- Removable wheel-mounted base

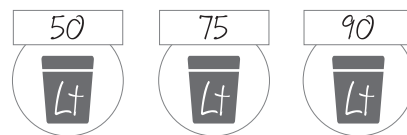

Watertight
pressed bottom



Art. 2450



Art. 2456



Art. 2457

Article	€	Opening	Capacity Lt	Max dim. cm	Kg	M	cm	Kg
2450	270,00	Manual	50	ø 40x50 h	6,5			
2451	295,00		70	ø 40x70 h	9,4	48x48x74 h	11	
2452	315,00		90	ø 40x90 h	11,8	53x50x92 h	13,9	
2455	300,00	Pedal operated	50	ø 40x50 h	10	45x45x63 h	11,5	
2456	330,00		70	ø 40x70 h	12,9	48x48x74 h	14,5	
2457	350,00		90	ø 40x90 h	15,3	53x50x92 h	17,4	

STAINLESS STEEL WASTE BINS AND SACK-HOLDERS

- Polished stainless steel rectangular waste bin
- Pedal operated opening
- Elastic fastening bag holder
- Front door
- Base with 2 wheels



Art. 2466



Art. 2467

- Wheeled white lacquered metal waste sack-holder
- Pedal operated opening
- Base with 2 wheels and 2 front feet



Art. 2438

- AISI 304 stainless steel dustbin for big waste sacks
- Pedal operated opening
- Base with 2 wheels and 2 front feet



Art. 2435

Article	€	Capacity Lt	Max. dim. cm	Kg	✂	📦 cm	Kg
2466	325,00	70	46x36x70 h	10,1	M	50x50x79 h	12
2467	372,00	110	46x36x90 h	13,1		48x45x95 h	15,3
2438	195,00	110	ø 41x100 h	12,5	M	63x57x100 h	13,5
2435	209,00		55x45x85 h	9,5		50x50x90 h	10,5

FAST-FOOD RUBBISH BINS





- AISI 430 stainless steel sheet structure (art. 2591)
- Plastic-coated galvanized sheet structure (Art. 2592 - 2593 - 2596 - 2598)
- Raised edge top for trays
- Swinging door for trays cleaning
- Sack-holder lower lockable door
- Adjustable nylon feet



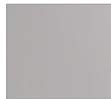

Art. 2591

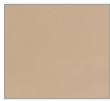

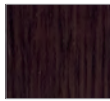
Art. 2592

Stainless steel	Grey	White
		
Art. 2591	Art. 2592	Art. 2593
Beige	Walnut	Wengé
		
Art. 2594	Art. 2596	Art. 2598

Colour table

Article	€	Colour	Capacity Lt	Max dim. cm	Kg			cm	Kg
2591	807,00	Stainless steel	80	60x60x120 h	42	M	65x65x130 h	50	
2592	742,00	Grey							
2593	742,00	White							
2594	742,00	Beige							
2596	742,00	Walnut							
2598	742,00	Wengé							

PEDAL OPERATED RECYCLING BINS

- Stainless steel structure, non-marking brushed finish
- Polypropylene and stainless steel lids
- Softclose closing
- Built-in side handles
- Polypropylene internal buckets
- ABS base
- Product compliant with HACCP system



Internal buckets detail



Art. 2560



Art. 2561



Art. 2562

Article	€	Capacity Lt	Max dim. cm	Kg	cm	Kg
2560	119,00	2x12	41x39x43 h	4,5	44x41x48 h	5
2561	153,00	3x12	60x39x43 h	6	63x41x47 h	6,5
2562	208,00	2x30	48x46x64 h	9,5	48x53x69 h	10

- Lacquered metal structure with lid
- Finish: white/yellow, white/red, white/green, white/blue, white/grey
- Up-and-over opening
- Sack-holder fastening ring



Opening detail

Article	€	Description	Capacity Lt	Max dim. cm				cm	
2565	207,00	Red for general waste	25	30x30x70 h	7,3	M	32x32x77 h	8	
2566	207,00	Yellow for plastic							
2567	207,00	Green for glass							
2568	207,00	Blue for paper							
2569	207,00	Grey for aluminium							

RECYCLING BIN

- 3 hole (plastic, paper and glass) and 3 internal sack-holders
- Micaceous black lacquered metal structure



Sack division detail:
paper, plastic and glass



Internal sack-holders

Art. 2570

Article	€	Capacity Lt	Max dim. cm	 Kg		 cm	 Kg
2570	403,00	3x25	48x48x71 h	13,9	M	48x48x74 h	15,5



SMALL METAL WASTE BINS

- Small waste bins in polished stainless steel or in epoxy powder coated metal
- Pedal operated opening
- Handle on the top
- Softclose closing with no handle on the top (Art. 2496 - 2496B)
- Internal plastic sack with handle
- Non-scratch non-slip ABS base and pedal
- NOTE: MINIMUM ORDER QUANTITY (depending on model)



Art. 2493



Art. 2493B



Art. 2495



Art. 2495B

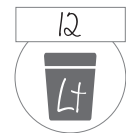

Art. 2494



Art. 2494B



Art. 2496



Art. 2496B



Article	€	Colour	Minimum order	Capacity Lt	Max dim. cm	Kg			cm	Kg
2493	23,00	Polished stainless steel	6 pcs.	3	ø 17x26 h	0,90	M	58x22x57 h	6	
2493B	19,00	White								
2494	29,00	Polished stainless steel	5	ø 21x27 h	1,10	67x25x62 h		7,20		
2494B	26,00	White								
2495	44,00	Polished stainless steel	4 pcs.	12	ø 25x39 h	2,10		56x58x43 h	9,3	
2495B	35,00	White								
2496	62,00	Polished stainless steel	-	20	ø 30x44 h	3,20		33x33x50 h	3,5	
2496B	56,00	White								

STAINLESS STEEL WASTE/PAPER BINS

- Rectangular polished stainless steel paper bins
- Non-scratch stainless steel swing lid



Art. 2431



Art. 2432

Article	€	Capacity Lt	Max dim. cm	Kg		cm	Kg
2431	257,00	30	30x20x70 h	4	M	33x24x75 h	5
2432	283,00	70	40x30x90 h	9		46x35x91 h	10

Accessories	€		Description	Suitable for
BIN1	20,00	1	Steel rod bag holder	2431
BIN2	25,00			2432



PUSH OPENING PAPER BINS

- Stainless steel or black lacquer metal paper bin
- Push opening



Art. 2404

Art. 2407



Art. 2410

Art. 2411



Art. 2409

Art. 2408

Article	€	Finish	Capacity Lt	Max dim. cm	Kg	cm	Kg	
2404	192,00	Stainless steel	45	ø 30x83 h	6	M	36x36x94 h	7
2407	142,00	Black						
2410	288,00	Stainless steel	75	ø 40x80 h	8		49x49x82 h	9
2411	234,00	Black						
2409	309,00	Stainless steel	88	ø 40x91 h	10		49x47x101 h	11
2408	247,00	Black						

Accessories	€	Description	Suitable for
BIN3	72,00	Galvanized sheet bucket	2404 - 2407
BIN4	93,00		2409 - 2408
BIN5	80,00		2410 - 2411



ASHTRAY TOP PAPER BINS

- Stainless steel or brass litter bin with ashtray mesh top



- Stainless steel or lacquered metal paper bin with ashtray top



Article	€	Colour	Max dim. cm	Kg	Paint	Box cm	Kg
2506	129,00	Polished stainless steel	ø 20x60 h	3	M	23x23x65 h	4
2508	188,00	Brass-plated					
2510	152,00	Polished stainless steel	ø 25x69 h	4		28x28x76 h	5
2512	218,00	Brass-plated					
2530N	89,00	Black micaceous lacquer	ø 25x62 h				
2531	105,00	Polished stainless steel					
Accessories	€	Image	Description	Suitable for	Image		
BIN6	17,00	1	Steel rod bag holder	2510 - 2512			
BIN7	17,00			2530N - 2531			

• Squared umbrella stands - satin stainless steel or black lacquered metal



Art. 2760



Art. 2761

• Black or white lacquered metal umbrella stand with stainless steel or brass final touches



Art. 2786





Art. 2787



Art. 2788



Art. 2789

Article	€	Colour	Max dim. cm	Kg		 cm	Kg
2760	107,00	Satin stainless steel	24x24x49 h	3	M	26x26x53 h	3,5
2761	89,00	Black					
2786	84,00	Black/stainless steel	ø 25x50 h				
2787	111,00	Black/brass					
2788	84,00	White/stainless steel					
2789	111,00	White/brass					

Rudolf **TANNER** Handelsges.m.b.H.

A-2320 Schwechat, Haydnstraße 26

Tel.: +43 664 33 50 500 +43 664 45 61 015

E-Mail: office@rtanner.at

Homepage: www.rtanner.at